

# Inspiron 14 3000

## Service Manual

**Computer Model:** Inspiron 14-3462  
**Regulatory Model:** P76G  
**Regulatory Type:** P76G001



# Notes, cautions, and warnings

---



**NOTE:** A NOTE indicates important information that helps you make better use of your product.



**CAUTION:** A CAUTION indicates either potential damage to hardware or loss of data and tells you how to avoid the problem.



**WARNING:** A WARNING indicates a potential for property damage, personal injury, or death.

---

**Copyright © 2016 Dell Inc. or its subsidiaries. All rights reserved.** Dell, EMC, and other trademarks are trademarks of Dell Inc. or its subsidiaries. Other trademarks may be trademarks of their respective owners.

2016 - 11

Rev. A00

# Contents

<b>Before working inside your computer.....</b>	<b>10</b>
Before you begin .....	10
Safety instructions.....	10
Recommended tools.....	11
Screw list.....	12
<b>After working inside your computer.....</b>	<b>14</b>
<b>Removing the battery.....</b>	<b>15</b>
Procedure.....	15
<b>Replacing the battery.....</b>	<b>16</b>
Procedure.....	16
<b>Removing the optical drive.....</b>	<b>17</b>
Prerequisites.....	17
Procedure.....	17
<b>Replacing the optical drive.....</b>	<b>20</b>
Procedure.....	20
Post-requisites.....	20
<b>Removing the keyboard.....</b>	<b>21</b>
Prerequisites.....	21
Procedure.....	21



<b>Replacing the keyboard.....</b>	<b>24</b>
Procedure.....	24
Post-requisites.....	24
<b>Removing the base cover.....</b>	<b>25</b>
Prerequisites.....	25
Procedure.....	25
<b>Replacing the base cover.....</b>	<b>30</b>
Procedure.....	30
Post-requisites.....	32
<b>Removing the memory module.....</b>	<b>33</b>
Prerequisites.....	33
Procedure.....	33
<b>Replacing the memory module.....</b>	<b>35</b>
Procedure.....	35
Post-requisites.....	36
<b>Removing the hard drive.....</b>	<b>37</b>
Prerequisites.....	37
Procedure.....	37
<b>Replacing the hard drive.....</b>	<b>40</b>
Procedure.....	40
Post-requisites.....	40
<b>Removing the wireless card.....</b>	<b>41</b>
Prerequisites.....	41
Procedure.....	41



<b>Replacing the wireless card.....</b>	<b>43</b>
Procedure.....	43
Post-requisites.....	44
<b>Removing the I/O board.....</b>	<b>45</b>
Prerequisites.....	45
Procedure.....	45
<b>Replacing the I/O board.....</b>	<b>47</b>
Procedure.....	47
Post-requisites.....	47
<b>Removing the coin-cell battery.....</b>	<b>48</b>
Prerequisites.....	48
Procedure.....	48
<b>Replacing the coin-cell battery.....</b>	<b>50</b>
Procedure.....	50
Post-requisites.....	50
<b>Removing the speakers.....</b>	<b>51</b>
Prerequisites.....	51
Procedure.....	51
<b>Replacing the speakers.....</b>	<b>53</b>
Procedure.....	53
Post-requisites.....	53
<b>Removing the heat sink.....</b>	<b>54</b>
Prerequisites.....	54
Procedure.....	54



<b>Replacing the heat sink.....</b>	<b>56</b>
Procedure.....	56
Post-requisites.....	56
<b>Removing the power-button board.....</b>	<b>57</b>
Prerequisites.....	57
Procedure.....	57
<b>Replacing the power-button board.....</b>	<b>59</b>
Procedure.....	59
Post-requisites.....	59
<b>Removing the display assembly.....</b>	<b>60</b>
Prerequisites.....	60
Procedure.....	60
<b>Replacing the display assembly.....</b>	<b>63</b>
Procedure.....	63
Post-requisites.....	63
<b>Removing the display bezel.....</b>	<b>64</b>
Prerequisites.....	64
Procedure.....	64
<b>Replacing the display bezel.....</b>	<b>66</b>
Procedure.....	66
Post-requisites.....	66
<b>Removing the display panel.....</b>	<b>67</b>
Prerequisites.....	67
Procedure.....	67



<b>Replacing the display panel.....</b>	<b>70</b>
Procedure.....	70
Post-requisites.....	70
<b>Removing the camera.....</b>	<b>71</b>
Prerequisites.....	71
Procedure.....	71
<b>Replacing the camera.....</b>	<b>73</b>
Procedure.....	73
Post-requisites.....	73
<b>Removing the display hinges.....</b>	<b>74</b>
Prerequisites.....	74
Procedure.....	74
<b>Replacing the display hinges.....</b>	<b>76</b>
Procedure.....	76
Post-requisites.....	76
<b>Removing the display cable.....</b>	<b>77</b>
Prerequisites.....	77
Procedure.....	77
<b>Replacing the display cable.....</b>	<b>80</b>
Procedure.....	80
Post-requisites.....	80
<b>Removing the system board.....</b>	<b>81</b>
Prerequisites.....	81
Procedure.....	81



<b>Replacing the system board.....</b>	<b>86</b>
Procedure.....	86
Post-requisites.....	87
<b>Removing the touch pad.....</b>	<b>88</b>
Prerequisites.....	88
Procedure.....	88
<b>Replacing the touch pad.....</b>	<b>92</b>
Procedure.....	92
Post-requisites.....	92
<b>Removing the power-adapter port.....</b>	<b>94</b>
Prerequisites.....	94
Procedure.....	94
<b>Replacing the power-adapter port.....</b>	<b>96</b>
Procedure.....	96
Post-requisites.....	96
<b>Removing the display back-cover and antenna assembly.....</b>	<b>97</b>
Prerequisites.....	97
Procedure.....	97
<b>Replacing the display back-cover and antenna assembly.....</b>	<b>99</b>
Procedure.....	99
Post-requisites.....	99





- Removing the palm rest..... 100**
  - Prerequisites.....100
  - Procedure..... 101
  
- Replacing the palm rest.....102**
  - Procedure.....102
  - Post-requisites..... 102
  
- Diagnostics.....103**
  
- Getting help and contacting Dell..... 105**
  - Self-help resources.....105
  - Contacting Dell..... 105





# Before working inside your computer

---



**NOTE:** The images in this document may differ from your computer depending on the configuration you ordered.

## Before you begin

- 1 Save and close all open files and exit all open applications.
- 2 Shut down your computer. Click **Start** →  **Power** → **Shut down**.
  -  **NOTE:** If you are using a different operating system, see the documentation of your operating system for shut-down instructions.
- 3 Disconnect your computer and all attached devices from their electrical outlets.
- 4 Disconnect all attached network devices and peripherals, such as keyboard, mouse, and monitor from your computer.
- 5 Remove any media card and optical disc from your computer, if applicable.
- 6 Close the display and turn the computer over.

## Safety instructions

Use the following safety guidelines to protect your computer from potential damage and ensure your personal safety.



**WARNING:** Before working inside your computer, read the safety information that shipped with your computer. For more safety best practices, see the Regulatory Compliance home page at [www.dell.com/regulatory\\_compliance](http://www.dell.com/regulatory_compliance).



**WARNING:** Disconnect all power sources before opening the computer cover or panels. After you finish working inside the computer, replace all covers, panels, and screws before connecting to the electrical outlet.



**CAUTION:** To avoid damaging the computer, ensure that the work surface is flat and clean.

- △ **CAUTION:** To avoid damaging the components and cards, handle them by their edges, and avoid touching pins and contacts.
- △ **CAUTION:** You should only perform troubleshooting and repairs as authorized or directed by the Dell technical assistance team. Damage due to servicing that is not authorized by Dell is not covered by your warranty. See the safety instructions that shipped with the product or at [www.dell.com/regulatory\\_compliance](http://www.dell.com/regulatory_compliance).
- △ **CAUTION:** Before touching anything inside your computer, ground yourself by touching an unpainted metal surface, such as the metal at the back of the computer. While you work, periodically touch an unpainted metal surface to dissipate static electricity, which could harm internal components.
- △ **CAUTION:** When you disconnect a cable, pull on its connector or on its pull tab, not on the cable itself. Some cables have connectors with locking tabs or thumb-screws that you must disengage before disconnecting the cable. When disconnecting cables, keep them evenly aligned to avoid bending any connector pins. When connecting cables, ensure that the ports and connectors are correctly oriented and aligned.
- △ **CAUTION:** Press and eject any installed card from the media-card reader.

## Recommended tools











The procedures in this document may require the following tools:





- Phillips screwdriver
- Plastic scribe



# Screw list

**Table 1. Screw list**

Component	Secured to	Screw type	Quantity	Screw image
Base cover	Palm-rest assembly	M2.5x8	8	
Base cover	Palm-rest assembly	M2x5	6	
Base cover	Palm-rest assembly	M2x2	3	
Display hinges	Display back-cover and antenna assembly	M2.5x2.5	6	
Display panel	Display-back cover and antenna assembly	M2x3	4	
Hard drive	Hard-drive assembly	M3x3	4	
Hard-drive bracket	Hard-drive assembly	M2x3	2	
Hinges	Palm-rest assembly	M2.5x8	3	
Optical-drive bracket	Optical drive	M2x3	1	
Power-adaptor port	Palm-rest assembly	M2x3	1	

<b>Component</b>	<b>Secured to</b>	<b>Screw type</b>	<b>Quantity</b>	<b>Screw image</b>
Power-button board	Palm-rest assembly	M2x2	1	
System board	Palm-rest assembly	M2x3	1	
Touch-pad board	Palm-rest assembly	M2x3	6	
Touch-pad bracket	Palm-rest assembly	M2x3	1	
Wireless-card bracket	System board	M2x3	1	



# After working inside your computer

---



**CAUTION: Leaving stray or loose screws inside your computer may severely damage your computer.**

- 1 Replace all screws and ensure that no stray screws remain inside your computer.
- 2 Connect any external devices, peripherals, or cables you removed before working on your computer.
- 3 Replace any media cards, discs, or any other parts that you removed before working on your computer.
- 4 Connect your computer and all attached devices to their electrical outlets.
- 5 Turn on your computer.

# Removing the battery

**!** **WARNING:** Before working inside your computer, read the safety information that shipped with your computer and follow the steps in [Before working inside your computer](#). After working inside your computer, follow the instructions in [After working inside your computer](#). For more safety best practices, see the Regulatory Compliance home page at [www.dell.com/regulatory\\_compliance](http://www.dell.com/regulatory_compliance).

## Procedure

- 1 Turn the computer over and slide the battery latch to the unlock position. You can hear a click sound when the battery is unlocked.
- 2 Using your fingertips, lift the battery at an angle and remove the battery off the computer base.

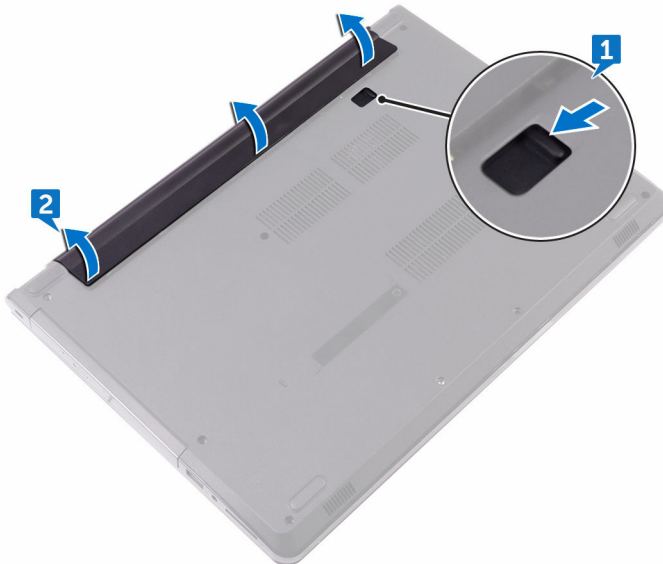

- 3 Turn the computer over, open the display, and press the power button for five seconds to ground the system board.



# Replacing the battery

---



**WARNING:** Before working inside your computer, read the safety information that shipped with your computer and follow the steps in [Before working inside your computer](#). After working inside your computer, follow the instructions in [After working inside your computer](#). For more safety best practices, see the Regulatory Compliance home page at [www.dell.com/regulatory\\_compliance](http://www.dell.com/regulatory_compliance).

## Procedure

Slide the tabs on the battery into the slots on the battery bay and snap the battery into place.



# Removing the optical drive

---



**WARNING:** Before working inside your computer, read the safety information that shipped with your computer and follow the steps in [Before working inside your computer](#). After working inside your computer, follow the instructions in [After working inside your computer](#). For more safety best practices, see the Regulatory Compliance home page at [www.dell.com/regulatory\\_compliance](http://www.dell.com/regulatory_compliance).

## Prerequisites

Remove the [battery](#).

## Procedure

- 1 Remove the screw (M2x5) that secures the optical-drive assembly to the base cover.
- 2 Using a plastic scribe, push to release the optical-drive assembly from the optical-drive bay.



- 3 Slide and remove the optical-drive assembly out of the optical-drive bay.

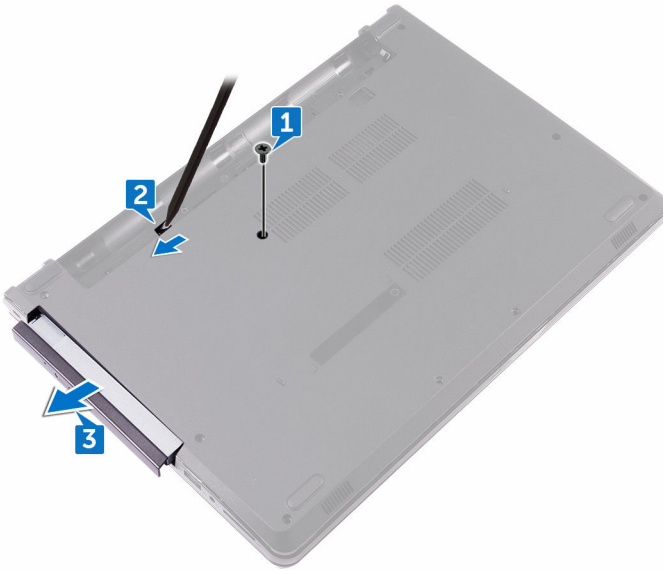

- 4 Remove the screw (M2x3) that secures the optical-drive bracket to the optical drive.

- 5** Remove the optical-drive bracket.

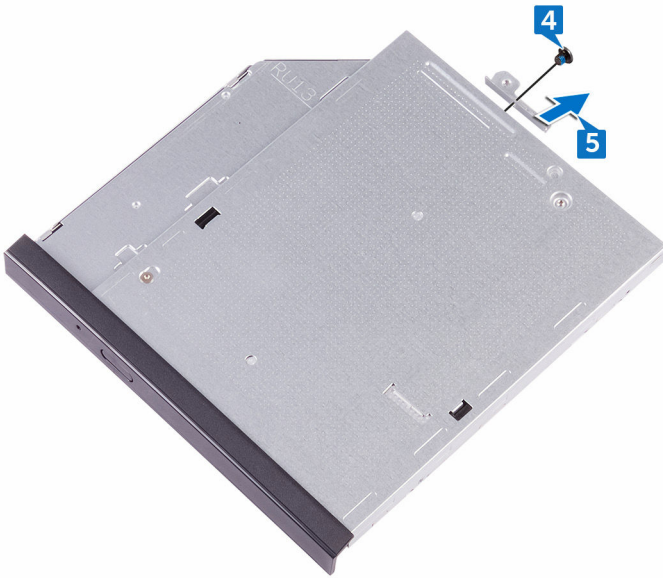

- 6** Pull the optical-drive bezel carefully to remove it from the optical drive.



# Replacing the optical drive

---



**WARNING:** Before working inside your computer, read the safety information that shipped with your computer and follow the steps in [Before working inside your computer](#). After working inside your computer, follow the instructions in [After working inside your computer](#). For more safety best practices, see the Regulatory Compliance home page at [www.dell.com/regulatory\\_compliance](http://www.dell.com/regulatory_compliance).

## Procedure

- 1 Align the tabs on the optical-drive bezel with the slots on the optical drive and snap the optical-drive bezel into place.
- 2 Align the screw hole on the optical-drive bracket with the screw hole on the optical drive.
- 3 Replace the screw (M2x3) that secures the optical-drive bracket to the optical drive.
- 4 Slide the optical-drive assembly into the optical-drive bay and align the screw hole on the optical-drive bracket with the screw hole on the base cover.
- 5 Replace the screw (M2x5) that secures the optical-drive assembly to the base cover.

## Post-requisites

Replace the [battery](#).

# Removing the keyboard

---



**WARNING:** Before working inside your computer, read the safety information that shipped with your computer and follow the steps in [Before working inside your computer](#). After working inside your computer, follow the instructions in [After working inside your computer](#). For more safety best practices, see the Regulatory Compliance home page at [www.dell.com/regulatory\\_compliance](http://www.dell.com/regulatory_compliance).

## Prerequisites

Remove the [battery](#).

## Procedure

- 1 Using a plastic scribe, gently release the tabs that secure the keyboard to the palm-rest assembly.
- 2 Slide the keyboard up to release it from the slots on the palm-rest assembly.



- 3 Turn the keyboard over, and place it on the palm-rest assembly.

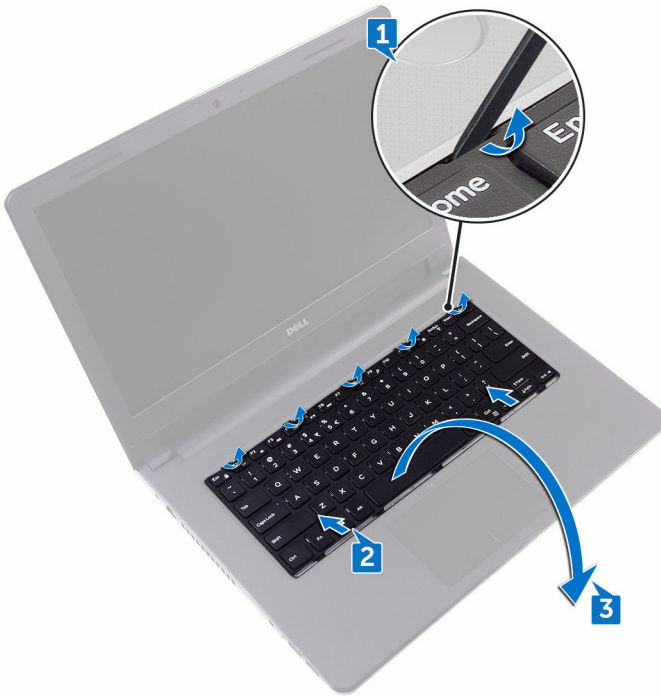

- 4 Open the latch, and disconnect the keyboard cable from the system board.

5 Lift the keyboard off the palm-rest assembly.

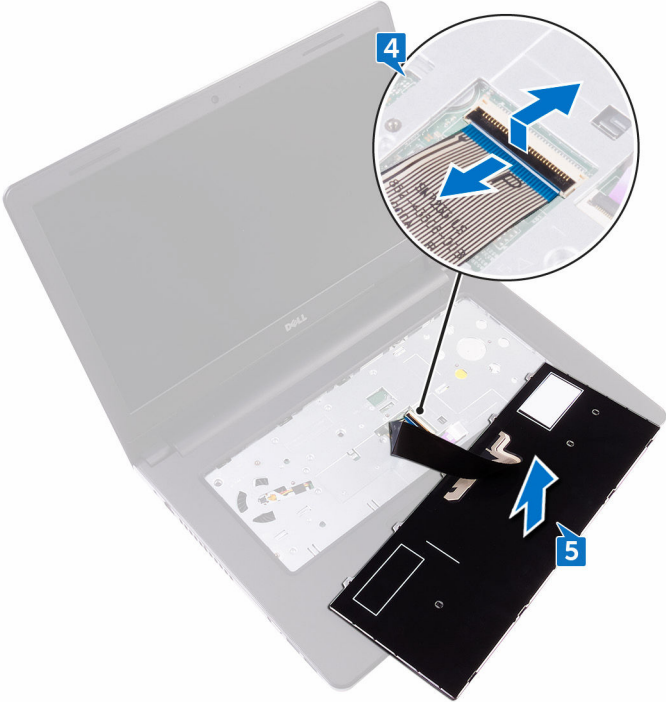

# Replacing the keyboard

---



**WARNING:** Before working inside your computer, read the safety information that shipped with your computer and follow the steps in [Before working inside your computer](#). After working inside your computer, follow the instructions in [After working inside your computer](#). For more safety best practices, see the Regulatory Compliance home page at [www.dell.com/regulatory\\_compliance](http://www.dell.com/regulatory_compliance).

## Procedure



**NOTE:** If you are installing a new keyboard, fold the cables the same way they are folded on the old keyboard.

- 1 Slide the keyboard cable into the connector and close the latch to secure the cable.
- 2 Turn the keyboard over.
- 3 Slide the tabs on the keyboard into the slots on the palm-rest assembly and snap the keyboard into place.

## Post-requisites

Replace the [battery](#).



# Removing the base cover

---



**WARNING:** Before working inside your computer, read the safety information that shipped with your computer and follow the steps in [Before working inside your computer](#). After working inside your computer, follow the instructions in [After working inside your computer](#). For more safety best practices, see the Regulatory Compliance home page at [www.dell.com/regulatory\\_compliance](http://www.dell.com/regulatory_compliance).

## Prerequisites

- 1 Remove the [battery](#).
- 2 Remove the [optical drive](#).
- 3 Remove the [keyboard](#).

## Procedure

- 1 Close the display, and turn the computer over.
- 2 Remove the eight screws (M2.5x8) that secure the base cover to the palm-rest assembly.
- 3 Remove the two screws (M2x5) that secure the base cover to the palm-rest assembly.



- 4 Remove the three screws (M2x2) that secure the base cover to the palm-rest assembly.

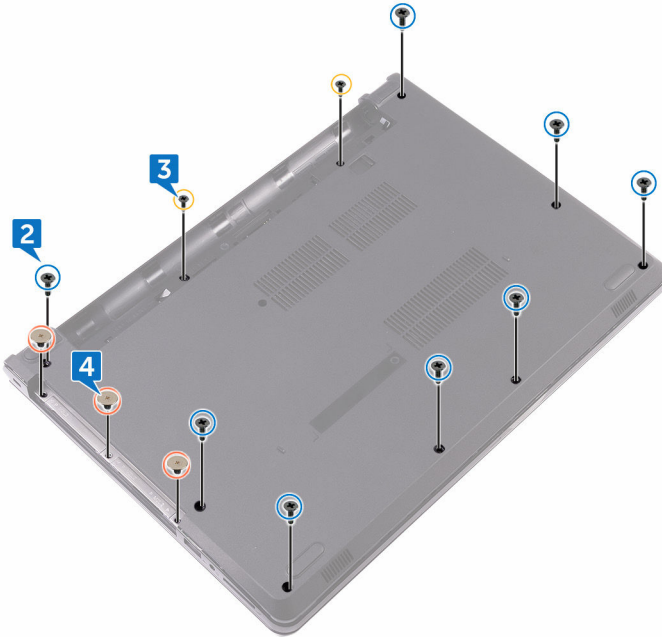

- 5 Turn the computer over, and open the display.
- 6 Remove the three screws (M2x5) that secure the base cover to the palm-rest assembly.

- 7 Open the latch, and disconnect the optical-drive cable from the system board.

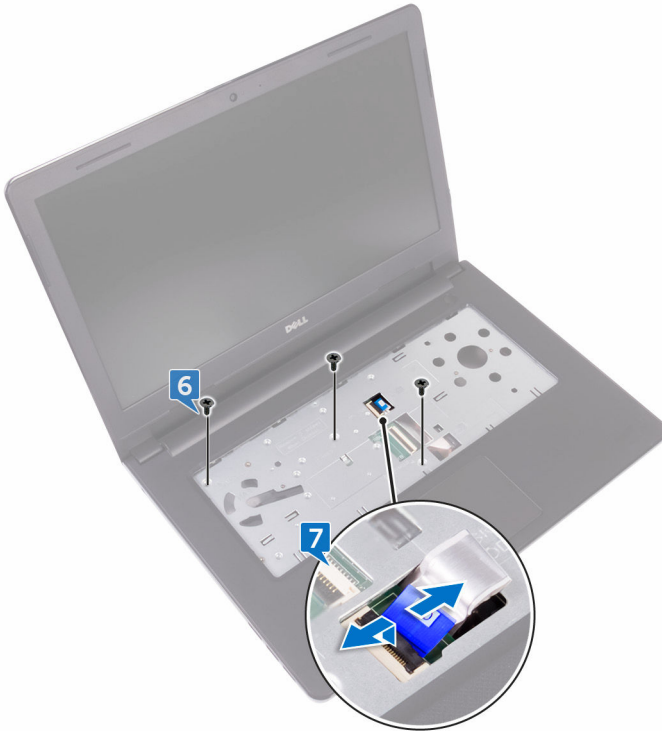

- 8 Close the display, and turn the computer over.
- 9 Using a plastic scribe, pry the base cover off the palm-rest assembly.



10 Lift the base cover off the palm-rest assembly.

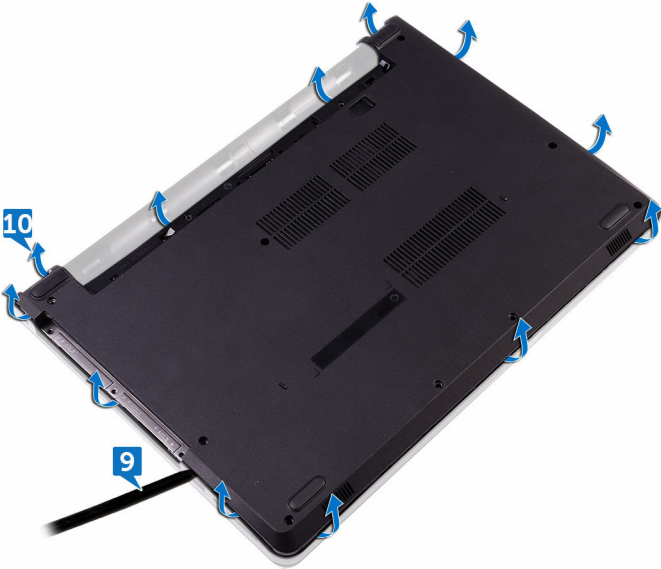

- 11 Release the optical-drive interposer from the tabs, and remove it from the base cover.

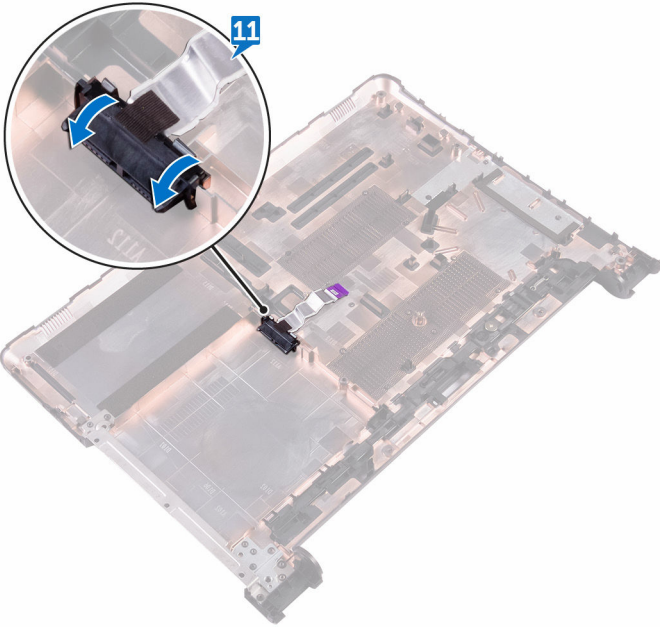

# Replacing the base cover

---



**WARNING:** Before working inside your computer, read the safety information that shipped with your computer and follow the steps in [Before working inside your computer](#). After working inside your computer, follow the instructions in [After working inside your computer](#). For more safety best practices, see the Regulatory Compliance home page at [www.dell.com/regulatory\\_compliance](http://www.dell.com/regulatory_compliance).

## Procedure

- 1 Slide the optical-drive interposer into the tabs on the base cover and snap it into place.

- 2 Place the base cover on the palm-rest assembly and route the optical-drive cable through the slot on the palm-rest assembly.



- 3 Slide the tabs on the base cover into the slots on the palm-rest assembly, and snap the base cover into place.
- 4 Slide the optical-drive cable into the connector on the system board and press down the latch to secure the cable.
- 5 Replace the three screws (M2x5) that secure the base cover to the palm-rest assembly.
- 6 Close the display, and turn the computer over.
- 7 Replace the three screws (M2x2) that secure the base cover to the palm-rest assembly.
- 8 Replace the two screws (M2x5) that secure the base cover to the palm-rest assembly.
- 9 Replace the eight screws (M2.5x8) that secure the base cover to the palm-rest assembly.



# Post-requisites

- 1 Replace the [keyboard](#).
- 2 Replace the [optical drive](#).
- 3 Replace the [battery](#).





# Removing the memory module

---



**WARNING:** Before working inside your computer, read the safety information that shipped with your computer and follow the steps in [Before working inside your computer](#). After working inside your computer, follow the instructions in [After working inside your computer](#). For more safety best practices, see the Regulatory Compliance home page at [www.dell.com/regulatory\\_compliance](http://www.dell.com/regulatory_compliance).

## Prerequisites

- 1 Remove the [battery](#).
- 2 Remove the [optical drive](#).
- 3 Remove the [keyboard](#).
- 4 Remove the [base cover](#).

## Procedure

- 1 Use your fingertips to carefully spread apart the securing-clips on each end of the memory-module slot until the memory module pops up.



2 Remove the memory module from the memory-module slot.

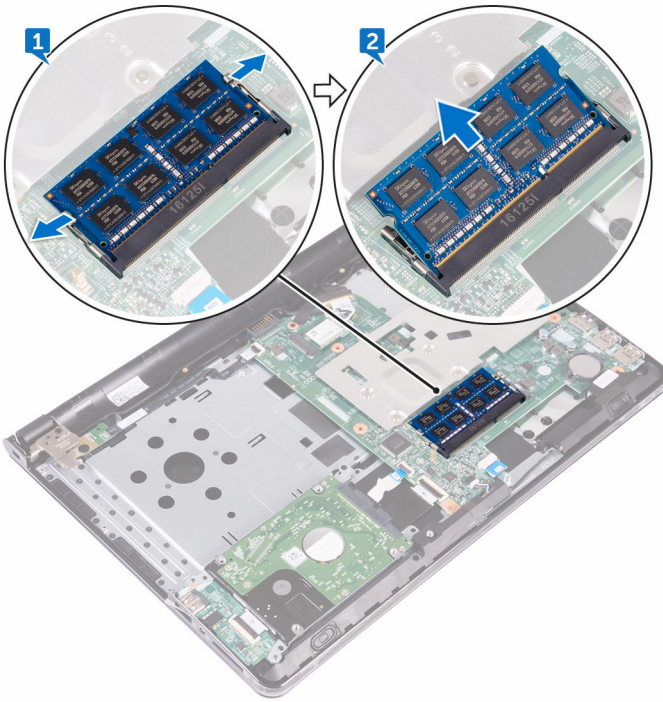

# Replacing the memory module

---



**WARNING:** Before working inside your computer, read the safety information that shipped with your computer and follow the steps in [Before working inside your computer](#). After working inside your computer, follow the instructions in [After working inside your computer](#). For more safety best practices, see the Regulatory Compliance home page at [www.dell.com/regulatory\\_compliance](http://www.dell.com/regulatory_compliance).

## Procedure

- 1 Align the notch on the memory module with the tab on the memory-module slot.



- 2 Slide the memory module firmly into the slot at an angle and press the memory module down until it clicks into place.

 **NOTE: If you do not hear the click, remove the memory module and reinstall it.**

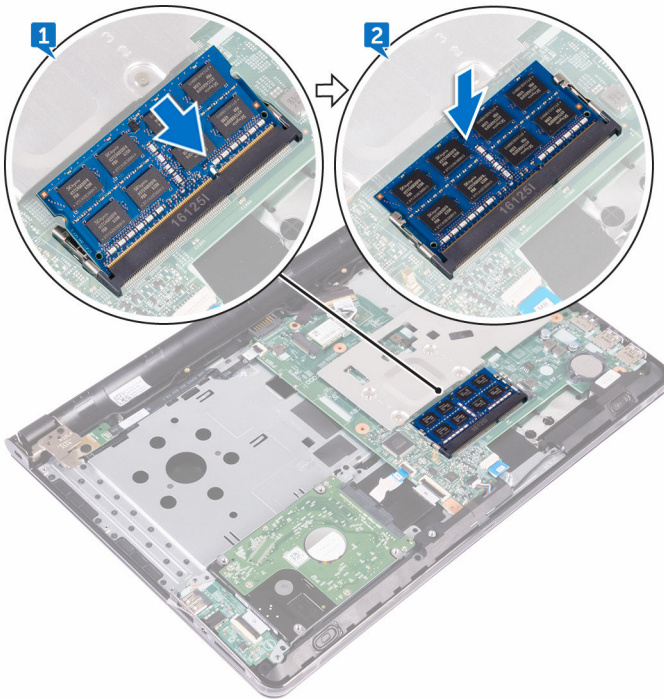

## Post-requisites

- 1 Replace the [base cover](#).
- 2 Replace the [keyboard](#).
- 3 Replace the [optical drive](#).
- 4 Replace the [battery](#).

# Removing the hard drive

---

 **WARNING:** Before working inside your computer, read the safety information that shipped with your computer and follow the steps in [Before working inside your computer](#). After working inside your computer, follow the instructions in [After working inside your computer](#). For more safety best practices, see the Regulatory Compliance home page at [www.dell.com/regulatory\\_compliance](http://www.dell.com/regulatory_compliance).

 **CAUTION:** Hard drives are fragile. Exercise care when handling the hard drive.

 **CAUTION:** To avoid data loss, do not remove the hard drive while the computer is in sleep or on state.

## Prerequisites

- 1 Remove the [battery](#).
- 2 Remove the [optical drive](#).
- 3 Remove the [keyboard](#).
- 4 Remove the [base cover](#).

## Procedure

- 1 Open the latch, and disconnect the hard-drive cable from the connector on the system board.
- 2 Remove the two screws (M2x3) that secure the hard-drive assembly to the palm-rest assembly.



- 3 Lift the hard-drive assembly along with its cable off the palm-rest assembly.

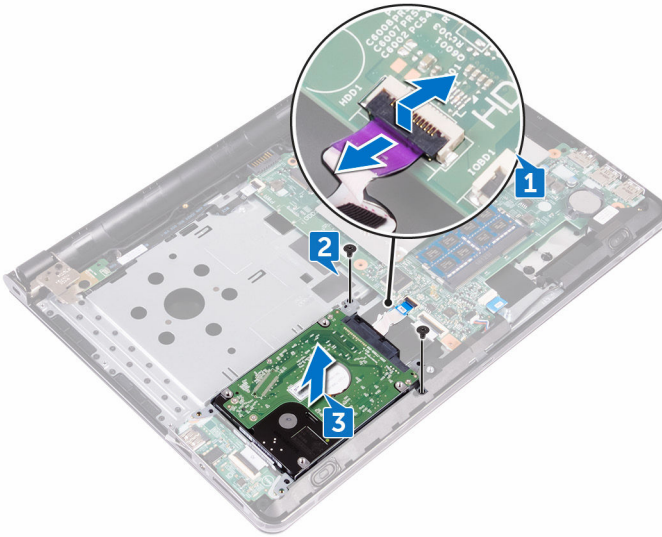

- 4 Remove the four screws (M3x3) that secure the hard-drive bracket to the hard-drive assembly.
- 5 Lift the hard-drive assembly off the hard-drive bracket.

6 Disconnect the interposer from the hard drive.

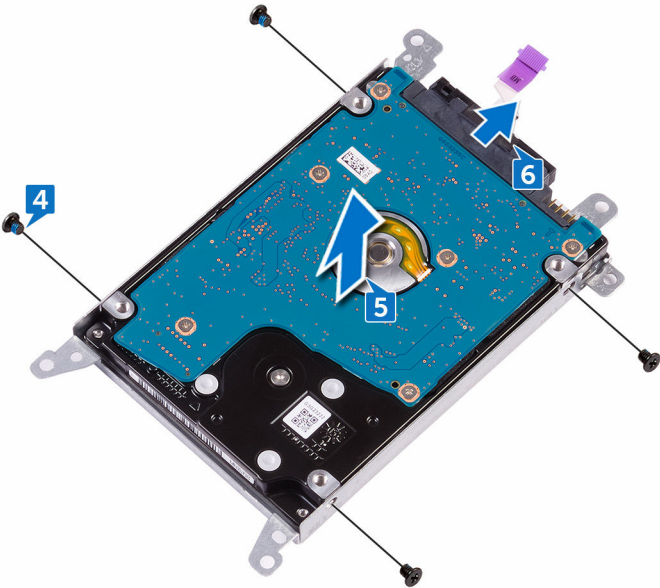

# Replacing the hard drive

---

 **WARNING:** Before working inside your computer, read the safety information that shipped with your computer and follow the steps in [Before working inside your computer](#). After working inside your computer, follow the instructions in [After working inside your computer](#). For more safety best practices, see the Regulatory Compliance home page at [www.dell.com/regulatory\\_compliance](http://www.dell.com/regulatory_compliance).

 **CAUTION:** Hard drives are fragile. Exercise care when handling the hard drive.

## Procedure

- 1 Connect the interposer to the hard drive.
- 2 Align the screw holes on the hard-drive bracket with the screw holes on the hard-drive assembly.
- 3 Replace the four screws (M3x3) that secure the hard-drive bracket to the hard-drive assembly.
- 4 Align the screw holes on the hard-drive assembly with the screw holes on the palm rest and keyboard assembly.
- 5 Replace the two screws (M2x3) that secure the hard-drive assembly to the palm-rest assembly.
- 6 Slide the hard-drive cable into the connector on the system board and press down the latch to secure the cable.

## Post-requisites

- 1 Replace the [base cover](#).
- 2 Replace the [keyboard](#).
- 3 Replace the [optical drive](#).
- 4 Replace the [battery](#).



# Removing the wireless card

---



**WARNING:** Before working inside your computer, read the safety information that shipped with your computer and follow the steps in [Before working inside your computer](#). After working inside your computer, follow the instructions in [After working inside your computer](#). For more safety best practices, see the Regulatory Compliance home page at [www.dell.com/regulatory\\_compliance](http://www.dell.com/regulatory_compliance).

## Prerequisites

- 1 Remove the [battery](#).
- 2 Remove the [optical drive](#).
- 3 Remove the [keyboard](#).
- 4 Remove the [base cover](#).

## Procedure

- 1 Remove the screw (M2x3) that secures the wireless-card bracket to the system board.
- 2 Slide and remove the wireless-card bracket.
- 3 Disconnect the antenna cables from the wireless card.



- 4 Slide and remove the wireless card from the wireless-card slot.

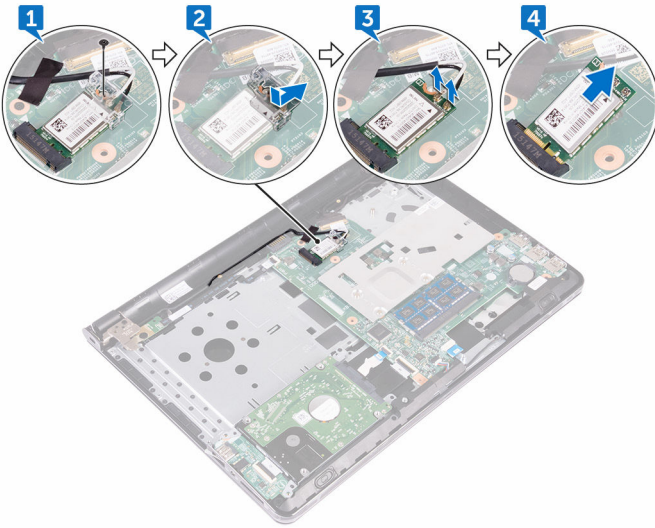

# Replacing the wireless card

---



**WARNING:** Before working inside your computer, read the safety information that shipped with your computer and follow the steps in [Before working inside your computer](#). After working inside your computer, follow the instructions in [After working inside your computer](#). For more safety best practices, see the Regulatory Compliance home page at [www.dell.com/regulatory\\_compliance](http://www.dell.com/regulatory_compliance).

## Procedure



**CAUTION:** To avoid damage to the wireless card, do not place any cables under it.

- 1 Align the notch on the wireless card with the tab on the wireless-card slot and insert the wireless card at an angle into the wireless-card slot.
- 2 Connect the antenna cables to the wireless card.

The following table provides the antenna-cable color scheme for the wireless card supported by your computer.

**Table 2. Antenna cable color scheme for wireless card**

Connectors on the wireless card	Antenna-cable color
Main (white triangle)	White
Auxiliary (black triangle)	Black

- 3 Slide to align the screw hole on the wireless-card bracket with the screw hole on the wireless card.



- 4 Replace the screw (M2x3) that secures the wireless-card bracket to the wireless card and the system board.

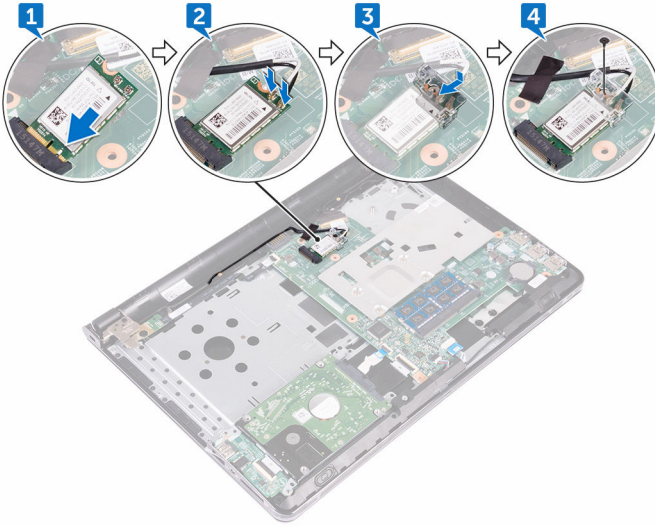

## Post-requisites

- 1 Replace the [base cover](#).
- 2 Replace the [keyboard](#).
- 3 Replace the [optical drive](#).
- 4 Replace the [battery](#).

# Removing the I/O board

---



**WARNING:** Before working inside your computer, read the safety information that shipped with your computer and follow the steps in [Before working inside your computer](#). After working inside your computer, follow the instructions in [After working inside your computer](#). For more safety best practices, see the Regulatory Compliance home page at [www.dell.com/regulatory\\_compliance](http://www.dell.com/regulatory_compliance).

## Prerequisites

- 1 Remove the [battery](#).
- 2 Remove the [optical drive](#).
- 3 Remove the [keyboard](#).
- 4 Remove the [base cover](#).
- 5 Remove the [hard drive](#).

## Procedure

- 1 Open the latch, and disconnect the I/O-board cable from the I/O board.
- 2 Push the securing tab to release the I/O board from the palm-rest assembly.



- 3 Lift the I/O board off the palm-rest assembly.

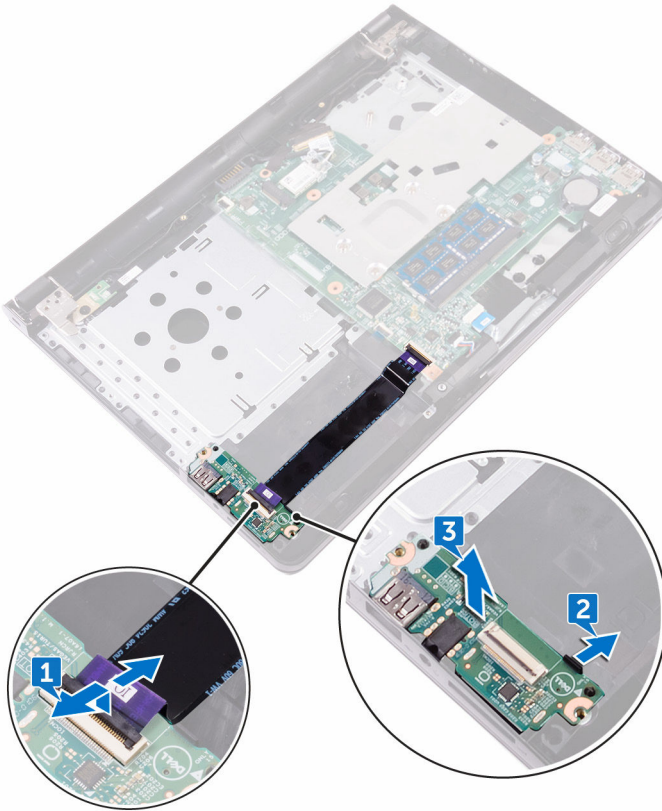

# Replacing the I/O board

---



**WARNING:** Before working inside your computer, read the safety information that shipped with your computer and follow the steps in [Before working inside your computer](#). After working inside your computer, follow the instructions in [After working inside your computer](#). For more safety best practices, see the Regulatory Compliance home page at [www.dell.com/regulatory\\_compliance](http://www.dell.com/regulatory_compliance).

## Procedure

- 1 Using the alignment posts, place the I/O board on the palm-rest assembly and snap the I/O board into place.
- 2 Slide the I/O-board cable into the connector on the I/O board and close the latch to secure the cable.

## Post-requisites

- 1 Replace the [hard drive](#).
- 2 Replace the [base cover](#).
- 3 Replace the [keyboard](#).
- 4 Replace the [optical drive](#).
- 5 Replace the [battery](#).



# Removing the coin-cell battery

---

 **WARNING:** Before working inside your computer, read the safety information that shipped with your computer and follow the steps in [Before working inside your computer](#). After working inside your computer, follow the instructions in [After working inside your computer](#). For more safety best practices, see the Regulatory Compliance home page at [www.dell.com/regulatory\\_compliance](http://www.dell.com/regulatory_compliance).

 **CAUTION:** Removing the coin-cell battery resets the BIOS setup program's settings to default. It is recommended that you note the BIOS setup program's settings before removing the coin-cell battery.

## Prerequisites

- 1 Remove the [battery](#).
- 2 Remove the [optical drive](#).
- 3 Remove the [keyboard](#).
- 4 Remove the [base cover](#).

## Procedure

Using a plastic scribe, gently pry out the coin-cell battery out of the battery socket on the system board.



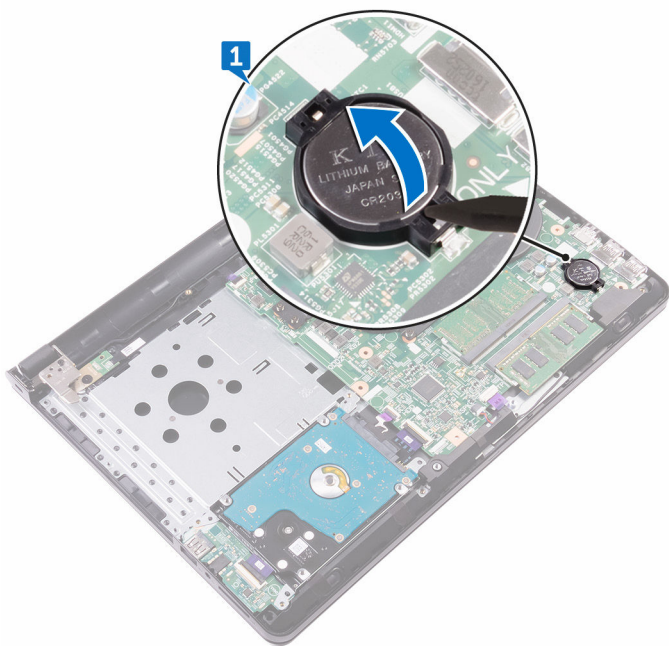

# Replacing the coin-cell battery

---



**WARNING:** Before working inside your computer, read the safety information that shipped with your computer and follow the steps in [Before working inside your computer](#). After working inside your computer, follow the instructions in [After working inside your computer](#). For more safety best practices, see the Regulatory Compliance home page at [www.dell.com/regulatory\\_compliance](http://www.dell.com/regulatory_compliance).

## Procedure

With the positive-side facing up, snap the coin-cell battery into the battery socket on the system board.

## Post-requisites

- 1 Replace the [base cover](#).
- 2 Replace the [keyboard](#).
- 3 Replace the [optical drive](#).
- 4 Replace the [battery](#).

# Removing the speakers

---



**WARNING:** Before working inside your computer, read the safety information that shipped with your computer and follow the steps in [Before working inside your computer](#). After working inside your computer, follow the instructions in [After working inside your computer](#). For more safety best practices, see the Regulatory Compliance home page at [www.dell.com/regulatory\\_compliance](http://www.dell.com/regulatory_compliance).

## Prerequisites

- 1 Remove the [battery](#).
- 2 Remove the [optical drive](#).
- 3 Remove the [keyboard](#).
- 4 Remove the [base cover](#).
- 5 Remove the [hard drive](#).

## Procedure

- 1 Disconnect the speaker cable from the system board.
- 2 Peel the tapes that secure the speaker to the palm-rest assembly.



3 Lift the speakers, along with the speaker cable, off the palm-rest assembly.

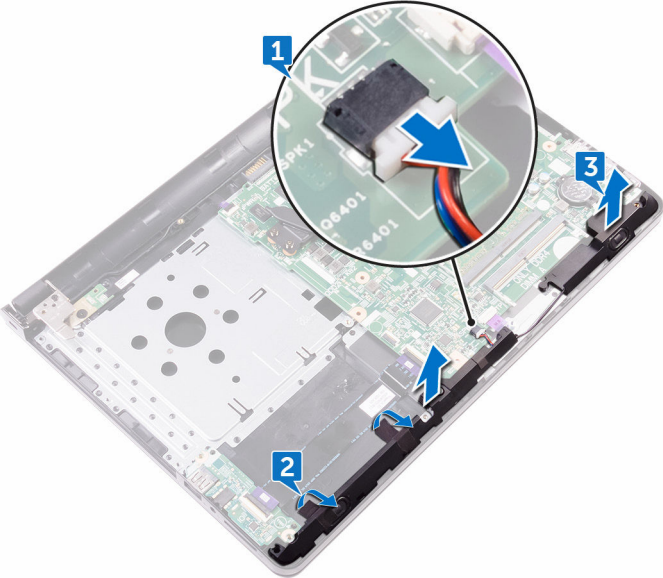

# Replacing the speakers

---



**WARNING:** Before working inside your computer, read the safety information that shipped with your computer and follow the steps in [Before working inside your computer](#). After working inside your computer, follow the instructions in [After working inside your computer](#). For more safety best practices, see the Regulatory Compliance home page at [www.dell.com/regulatory\\_compliance](http://www.dell.com/regulatory_compliance).

## Procedure

- 1 Using the alignment posts, place the speakers on the palm-rest assembly.
- 2 Adhere the tapes that secure the speakers to the palm-rest assembly.
- 3 Connect the speaker cable to the system board.

## Post-requisites

- 1 Replace the [hard drive](#).
- 2 Replace the [base cover](#).
- 3 Replace the [keyboard](#).
- 4 Replace the [optical drive](#).
- 5 Replace the [battery](#).



# Removing the heat sink

---

 **WARNING:** Before working inside your computer, read the safety information that shipped with your computer and follow the steps in [Before working inside your computer](#). After working inside your computer, follow the instructions in [After working inside your computer](#). For more safety best practices, see the Regulatory Compliance home page at [www.dell.com/regulatory\\_compliance](http://www.dell.com/regulatory_compliance).

 **WARNING:** The heat sink may become hot during normal operation. Allow sufficient time for the heat sink to cool before you touch it.

 **CAUTION:** For maximum cooling of the processor, do not touch the heat transfer areas on the heat sink. The oils in your skin can reduce the heat transfer capability of the thermal grease.

## Prerequisites

- 1 Remove the [battery](#).
- 2 Remove the [optical drive](#).
- 3 Remove the [keyboard](#).
- 4 Remove the [base cover](#).

## Procedure

- 1 In sequential order (as indicated on the heat sink), loosen the captive screws that secure the heat sink to the system board.

- 2 Lift the heat sink off the system board.

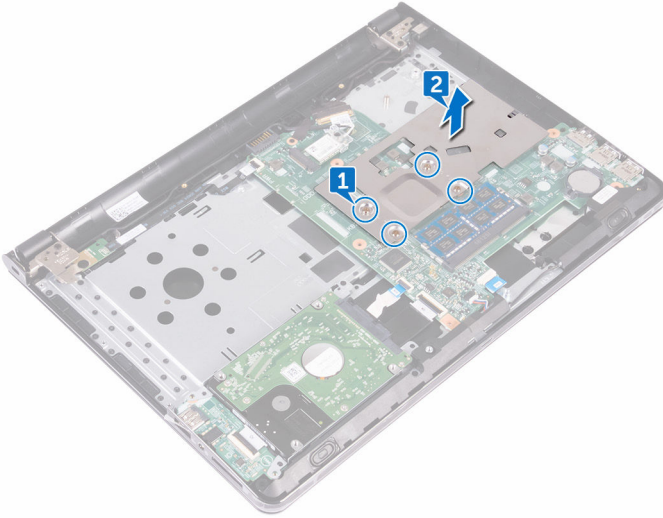

# Replacing the heat sink

---



**WARNING:** Before working inside your computer, read the safety information that shipped with your computer and follow the steps in [Before working inside your computer](#). After working inside your computer, follow the instructions in [After working inside your computer](#). For more safety best practices, see the Regulatory Compliance home page at [www.dell.com/regulatory\\_compliance](http://www.dell.com/regulatory_compliance).



**CAUTION:** Incorrect alignment of the heat sink can damage the system board and processor.



**NOTE:** The original thermal grease can be reused if the original system board and heat sink are reinstalled together. If either the system board or the heat sink is replaced, use the thermal pad provided in the kit to ensure that thermal conductivity is achieved.

## Procedure

- 1 Place the heat sink on the system board and align the screw holes on the heat sink with the screw holes on the system board.
- 2 In sequential order (indicated on the heat sink), tighten the captive screws that secure the heat sink to the system board.

## Post-requisites

- 1 Replace the [base cover](#).
- 2 Replace the [keyboard](#).
- 3 Replace the [optical drive](#).
- 4 Replace the [battery](#).



# Removing the power-button board

---



**WARNING:** Before working inside your computer, read the safety information that shipped with your computer and follow the steps in [Before working inside your computer](#). After working inside your computer, follow the instructions in [After working inside your computer](#). For more safety best practices, see the Regulatory Compliance home page at [www.dell.com/regulatory\\_compliance](http://www.dell.com/regulatory_compliance).

## Prerequisites

- 1 Remove the [battery](#).
- 2 Remove the [optical drive](#).
- 3 Remove the [keyboard](#).
- 4 Remove the [base cover](#).

## Procedure

- 1 Open the latch, and disconnect the power-button board cable from the system board.
- 2 Remove the screw (M2.5x8) that secures the display hinge to the palm-rest assembly.
- 3 Lift the display hinge.
- 4 Remove the screw (M2x2) that secures the power-button board to the palm-rest assembly.
- 5 Peel the tape that secures the power-button board to the palm-rest assembly.



- 6 Release the power-button board from the tab, and lift it along with the cable off the palm-rest assembly.

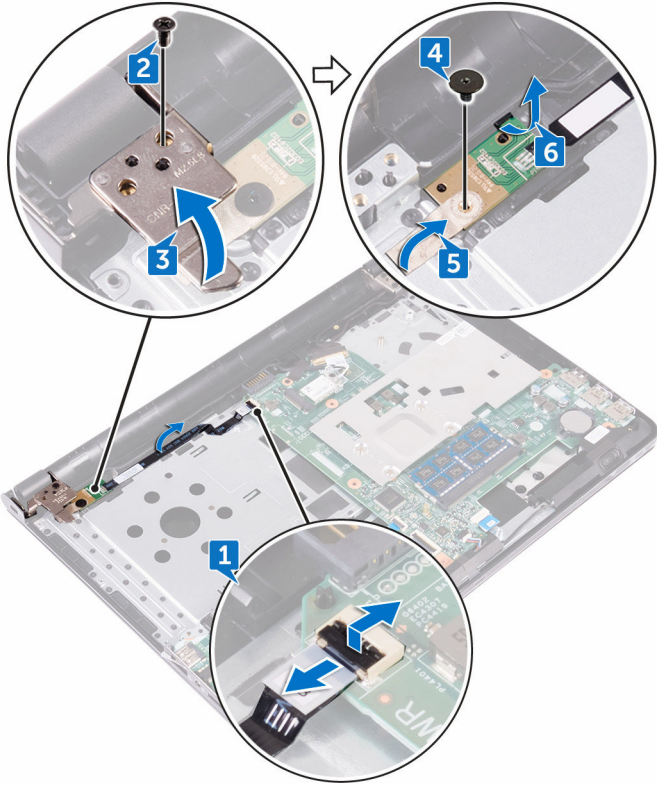

# Replacing the power-button board

---



**WARNING:** Before working inside your computer, read the safety information that shipped with your computer and follow the steps in [Before working inside your computer](#). After working inside your computer, follow the instructions in [After working inside your computer](#). For more safety best practices, see the Regulatory Compliance home page at [www.dell.com/regulatory\\_compliance](http://www.dell.com/regulatory_compliance).

## Procedure

- 1 Slide the power-button board under the tab on the palm-rest assembly.
- 2 Using the alignment post, place the power-button board on the palm-rest assembly.
- 3 Align the screw hole on the power-button board with the screw hole on the palm-rest assembly.
- 4 Replace the screw (M2x2) that secures the power-button board to the palm-rest assembly.
- 5 Adhere the tape that secures the power-button board to the palm-rest assembly.
- 6 Close the display hinge, and replace the screw (M2.5x8) that secures the display hinge to the palm-rest assembly.
- 7 Connect the power-button board cable to the system board.

## Post-requisites

- 1 Replace the [base cover](#).
- 2 Replace the [keyboard](#).
- 3 Replace the [optical drive](#).
- 4 Replace the [battery](#).



# Removing the display assembly

---



**WARNING:** Before working inside your computer, read the safety information that shipped with your computer and follow the steps in [Before working inside your computer](#). After working inside your computer, follow the instructions in [After working inside your computer](#). For more safety best practices, see the Regulatory Compliance home page at [www.dell.com/regulatory\\_compliance](http://www.dell.com/regulatory_compliance).

## Prerequisites

- 1 Remove the [battery](#).
- 2 Remove the [optical drive](#).
- 3 Remove the [keyboard](#).
- 4 Remove the [base cover](#).
- 5 Remove the [wireless card](#).

## Procedure

- 1 Peel the tape that adheres the display cable to the system board.
- 2 Open the latch that secures the display cable into position.
- 3 Disconnect the display cable from the system board.

- 4 Note the antenna-cable routing, and remove the antenna cable from the routing guides on the palm-rest assembly.

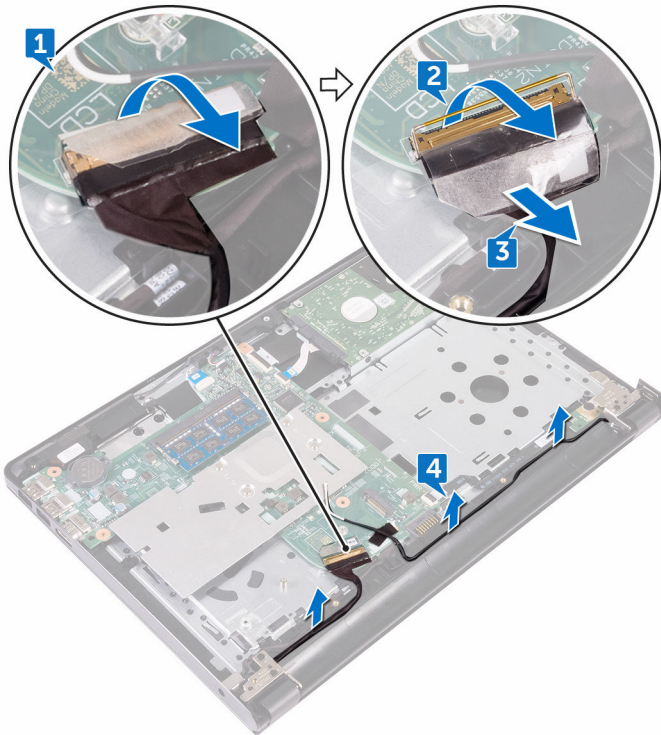

- 5 Turn the computer over and open the display at an angle of 90 degrees.
- 6 Turn the computer over and place it on the edge of the table in a position that allows access to the screws on the display hinges.
- 7 Remove the three screws (M2.5x8) that secure the display-hinge brackets to the palm-rest assembly.

- 8** Carefully lift the display assembly from the palm-rest assembly.

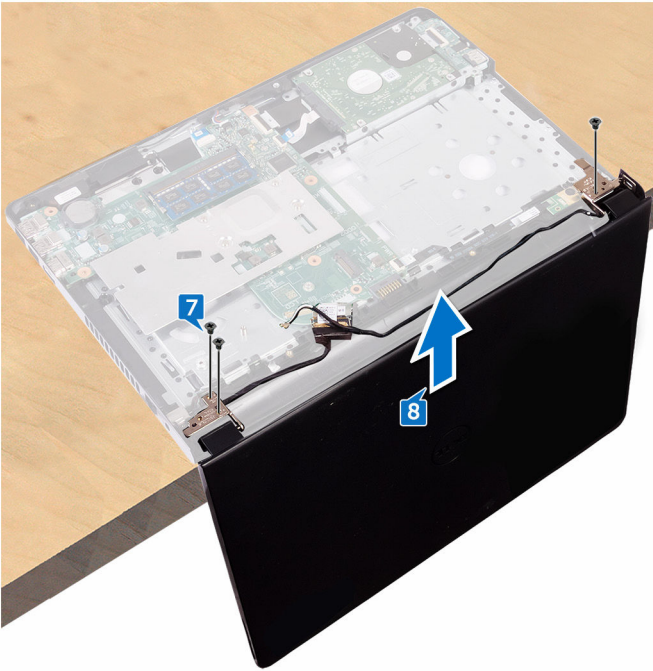

- 9** Carefully place the display assembly on a clean and flat surface.

# Replacing the display assembly

---



**WARNING:** Before working inside your computer, read the safety information that shipped with your computer and follow the steps in [Before working inside your computer](#). After working inside your computer, follow the instructions in [After working inside your computer](#). For more safety best practices, see the Regulatory Compliance home page at [www.dell.com/regulatory\\_compliance](http://www.dell.com/regulatory_compliance).

## Procedure

- 1 Place the palm-rest assembly at the edge of the table.
- 2 Align the screw holes on the palm-rest assembly with the screw holes on the display hinges.
- 3 Replace the three screws (M2.5x8) that secure the display hinges to the palm-rest assembly.
- 4 Route the antenna cables through the routing guides on the palm-rest assembly.
- 5 Connect the display cable from the system board.
- 6 Close the latch that secures the display cable to the system board.
- 7 Adhere the tape that secures the display cable to the system board.

## Post-requisites

- 1 Replace the [wireless card](#).
- 2 Replace the [base cover](#).
- 3 Replace the [keyboard](#).
- 4 Replace the [optical drive](#).
- 5 Replace the [battery](#).



# Removing the display bezel

---



**WARNING:** Before working inside your computer, read the safety information that shipped with your computer and follow the steps in [Before working inside your computer](#). After working inside your computer, follow the instructions in [After working inside your computer](#). For more safety best practices, see the Regulatory Compliance home page at [www.dell.com/regulatory\\_compliance](http://www.dell.com/regulatory_compliance).

## Prerequisites

- 1 Remove the [battery](#).
- 2 Remove the [optical drive](#).
- 3 Remove the [keyboard](#).
- 4 Remove the [base cover](#).
- 5 Remove the [wireless card](#).
- 6 Remove the [display assembly](#).

## Procedure

- 1 Using your fingertips, carefully pry up the inside edge of the display bezel.



- 2 Remove the display bezel off the display back-cover and antenna assembly.



# Replacing the display bezel

---



**WARNING:** Before working inside your computer, read the safety information that shipped with your computer and follow the steps in [Before working inside your computer](#). After working inside your computer, follow the instructions in [After working inside your computer](#). For more safety best practices, see the Regulatory Compliance home page at [www.dell.com/regulatory\\_compliance](http://www.dell.com/regulatory_compliance).

## Procedure

Align the display bezel with the display back-cover and antenna assembly, and gently snap the display bezel into place.

## Post-requisites

- 1 Replace the [display assembly](#).
- 2 Replace the [wireless card](#).
- 3 Replace the [base cover](#).
- 4 Replace the [keyboard](#).
- 5 Replace the [optical drive](#).
- 6 Replace the [battery](#).

# Removing the display panel

---



**WARNING:** Before working inside your computer, read the safety information that shipped with your computer and follow the steps in [Before working inside your computer](#). After working inside your computer, follow the instructions in [After working inside your computer](#). For more safety best practices, see the Regulatory Compliance home page at [www.dell.com/regulatory\\_compliance](http://www.dell.com/regulatory_compliance).

## Prerequisites

- 1 Remove the [battery](#).
- 2 Remove the [optical drive](#).
- 3 Remove the [keyboard](#).
- 4 Remove the [base cover](#).
- 5 Remove the [wireless card](#).
- 6 Remove the [display assembly](#).
- 7 Remove the [display bezel](#).

## Procedure

- 1 Remove the four screws (M2x3) that secure the display panel to the display back-cover and antenna assembly.



- 2 Lift the display panel gently, and turn it over.

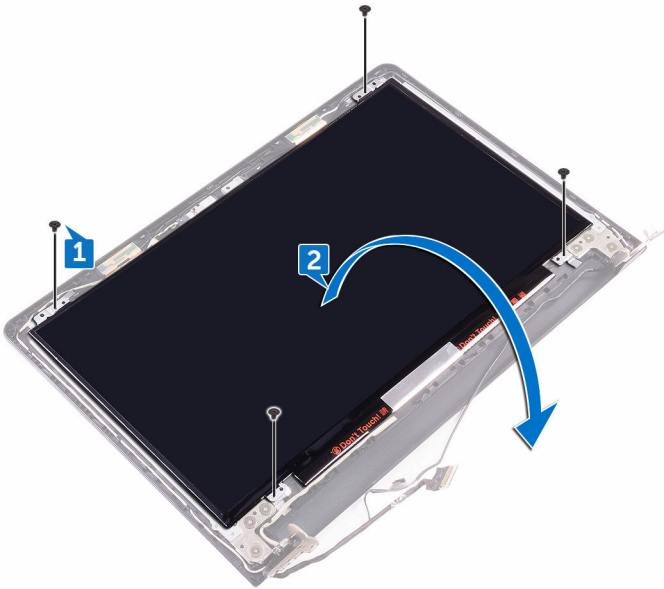

- 3 Peel the tape that secures the display cable to the display back-cover and antenna assembly.
- 4 Lift the latch, and disconnect the display cable from the display panel.

5 Lift the display panel away from the display back-cover and antenna assembly.

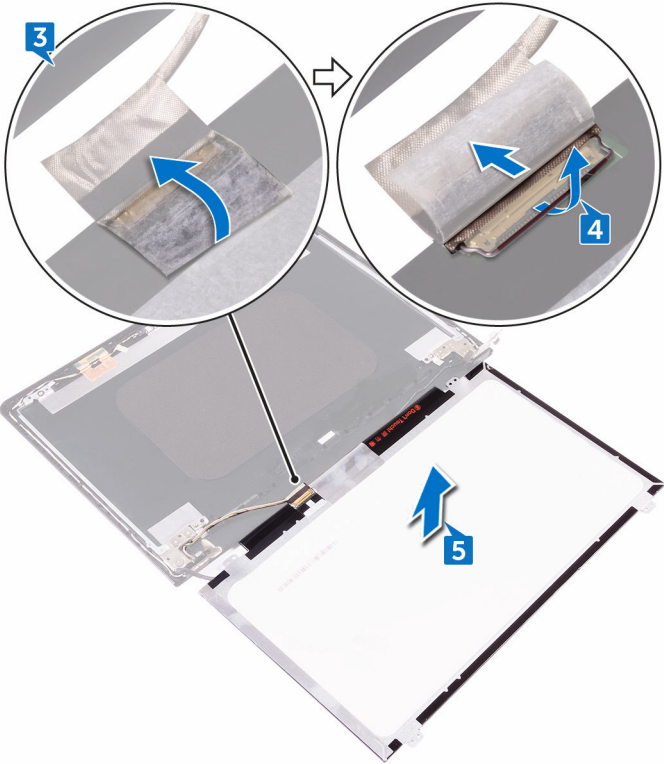

# Replacing the display panel

---



**WARNING:** Before working inside your computer, read the safety information that shipped with your computer and follow the steps in [Before working inside your computer](#). After working inside your computer, follow the instructions in [After working inside your computer](#). For more safety best practices, see the Regulatory Compliance home page at [www.dell.com/regulatory\\_compliance](http://www.dell.com/regulatory_compliance).

## Procedure

- 1 Connect the display cable to the display-panel connector on the display panel.
- 2 Close the latch, and adhere the tape that secures the display cable to the display back-cover and antenna assembly.
- 3 Place the display panel gently on the display back-cover and antenna assembly.
- 4 Align the screw holes on the display panel with the screw holes on the display back-cover and antenna assembly.
- 5 Replace the four screws (M2x3) that secure the display panel to the display back-cover and antenna assembly.

## Post-requisites

- 1 Replace the [display bezel](#).
- 2 Replace the [display assembly](#).
- 3 Replace the [wireless card](#).
- 4 Replace the [base cover](#).
- 5 Replace the [keyboard](#).
- 6 Replace the [optical drive](#).
- 7 Replace the [battery](#).

# Removing the camera

---



**WARNING:** Before working inside your computer, read the safety information that shipped with your computer and follow the steps in [Before working inside your computer](#). After working inside your computer, follow the instructions in [After working inside your computer](#). For more safety best practices, see the Regulatory Compliance home page at [www.dell.com/regulatory\\_compliance](http://www.dell.com/regulatory_compliance).

## Prerequisites

- 1 Remove the [battery](#).
- 2 Remove the [optical drive](#).
- 3 Remove the [keyboard](#).
- 4 Remove the [base cover](#).
- 5 Remove the [wireless card](#).
- 6 Remove the [display assembly](#).
- 7 Remove the [display bezel](#).
- 8 Remove the [display panel](#).

## Procedure

- 1 Peel off the foil from the camera module.
- 2 Using a plastic scribe, pry the camera module, and then lift the camera module at an angle.



**3** Disconnect the camera cable from the camera module.

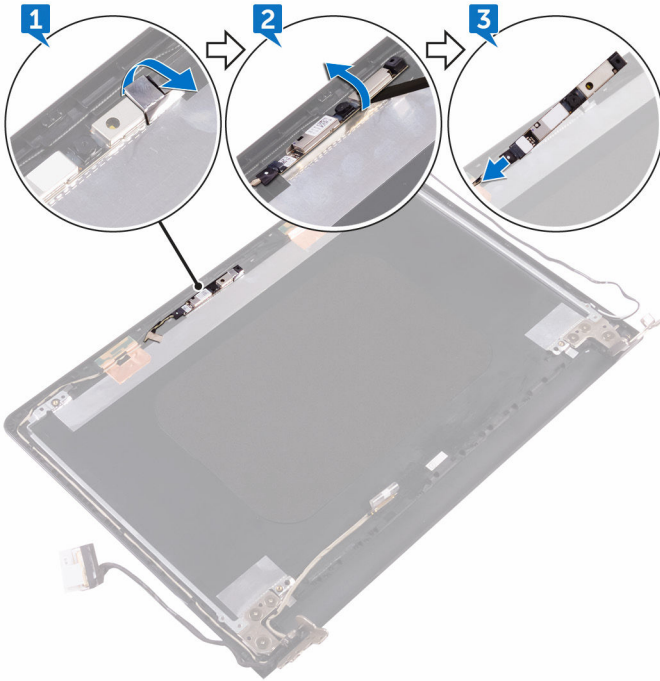



# Replacing the camera

---



**WARNING:** Before working inside your computer, read the safety information that shipped with your computer and follow the steps in [Before working inside your computer](#). After working inside your computer, follow the instructions in [After working inside your computer](#). For more safety best practices, see the Regulatory Compliance home page at [www.dell.com/regulatory\\_compliance](http://www.dell.com/regulatory_compliance).

## Procedure

- 1 Connect the camera cable to the camera module.
- 2 Using the alignment post, place the camera on the display back-cover and antenna assembly.
- 3 Adhere the foil to the camera module.

## Post-requisites

- 1 Replace the [display panel](#).
- 2 Replace the [display bezel](#).
- 3 Replace the [display assembly](#).
- 4 Replace the [wireless card](#).
- 5 Replace the [base cover](#).
- 6 Replace the [keyboard](#).
- 7 Replace the [optical drive](#).
- 8 Replace the [battery](#).



# Removing the display hinges

---



**WARNING:** Before working inside your computer, read the safety information that shipped with your computer and follow the steps in [Before working inside your computer](#). After working inside your computer, follow the instructions in [After working inside your computer](#). For more safety best practices, see the Regulatory Compliance home page at [www.dell.com/regulatory\\_compliance](http://www.dell.com/regulatory_compliance).

## Prerequisites

- 1 Remove the [battery](#).
- 2 Remove the [optical drive](#).
- 3 Remove the [keyboard](#).
- 4 Remove the [base cover](#).
- 5 Remove the [wireless card](#).
- 6 Remove the [display assembly](#).
- 7 Remove the [display bezel](#).
- 8 Remove the [display panel](#).

## Procedure

- 1 Remove the three screws (M2.5x2.5) that secure the left display hinge to the display back-cover and antenna assembly.
- 2 Lift the left display hinge off the display back-cover and antenna assembly.
- 3 Remove the three screws (M2.5x2.5) that secure the right display hinge to the display back-cover and antenna assembly.

- 4 Lift the right display hinge off the display back-cover and antenna assembly.

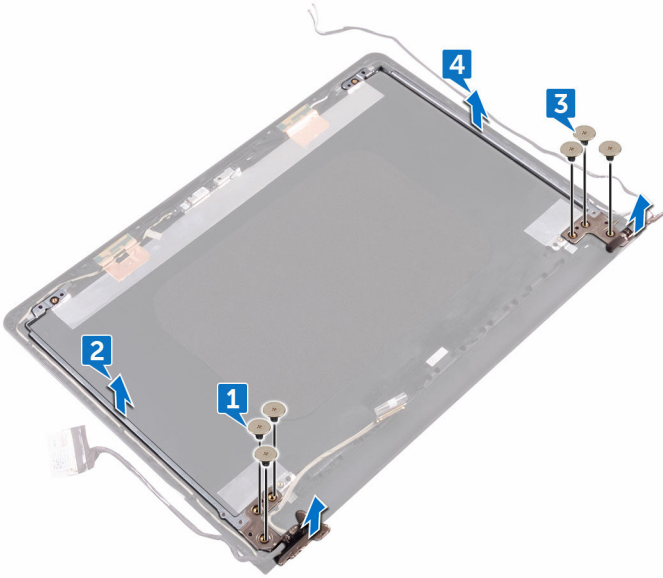

# Replacing the display hinges

---



**WARNING:** Before working inside your computer, read the safety information that shipped with your computer and follow the steps in [Before working inside your computer](#). After working inside your computer, follow the instructions in [After working inside your computer](#). For more safety best practices, see the Regulatory Compliance home page at [www.dell.com/regulatory\\_compliance](http://www.dell.com/regulatory_compliance).

## Procedure

- 1 Align the screw holes on the display hinges with the screw holes on the display back-cover and antenna assembly.
- 2 Replace the six (M2.5x2.5) screws that secure the display hinges to the display back-cover and antenna assembly.

## Post-requisites

- 1 Replace the [display panel](#).
- 2 Replace the [display bezel](#).
- 3 Replace the [display assembly](#).
- 4 Replace the [wireless card](#).
- 5 Replace the [base cover](#).
- 6 Replace the [keyboard](#).
- 7 Replace the [optical drive](#).
- 8 Replace the [battery](#).

# Removing the display cable

---



**WARNING:** Before working inside your computer, read the safety information that shipped with your computer and follow the steps in [Before working inside your computer](#). After working inside your computer, follow the instructions in [After working inside your computer](#). For more safety best practices, see the Regulatory Compliance home page at [www.dell.com/regulatory\\_compliance](http://www.dell.com/regulatory_compliance).

## Prerequisites

- 1 Remove the [battery](#).
- 2 Remove the [optical drive](#).
- 3 Remove the [keyboard](#).
- 4 Remove the [base cover](#).
- 5 Remove the [wireless card](#).
- 6 Remove the [display assembly](#).
- 7 Remove the [display bezel](#).
- 8 Remove the [display panel](#).
- 9 Remove the [camera](#).

## Procedure

- 1 Remove the three screws (M2.5x2.5) that secure the left display hinge to the display back-cover and antenna assembly.



- 
- 2** Lift the left display hinge off the display back-cover and antenna assembly.

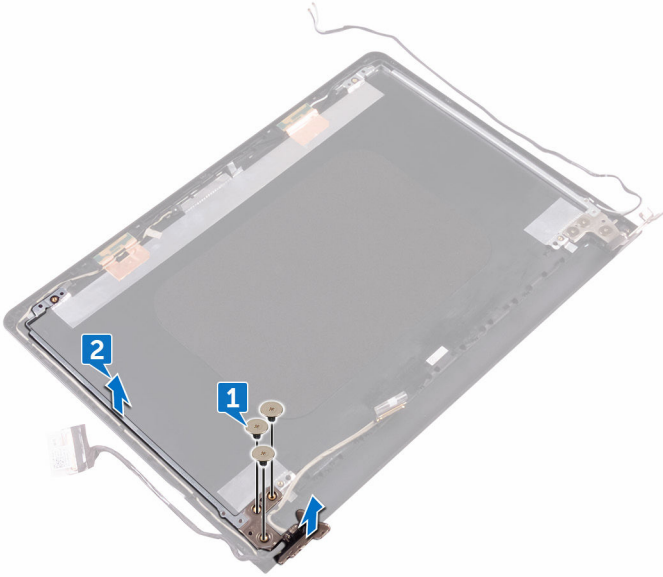

- 
- 
- 3** Note the display cable routing, and remove the display cable from the routing guides on the display back-cover and antenna assembly.

- 4 Remove the display cable off the display back-cover and antenna assembly.



# Replacing the display cable

---



**WARNING:** Before working inside your computer, read the safety information that shipped with your computer and follow the steps in [Before working inside your computer](#). After working inside your computer, follow the instructions in [After working inside your computer](#). For more safety best practices, see the Regulatory Compliance home page at [www.dell.com/regulatory\\_compliance](http://www.dell.com/regulatory_compliance).

## Procedure

- 1 Route the display cable through the routing guides on the display back-cover and antenna assembly.
- 2 Place the left display hinge on the display back-cover and antenna assembly.
- 3 Replace the three screws (M2.5x2.5) that secure the left display hinge to the display back-cover and antenna assembly.

## Post-requisites

- 1 Replace the [camera](#).
- 2 Replace the [display panel](#).
- 3 Replace the [display bezel](#).
- 4 Replace the [display assembly](#).
- 5 Replace the [wireless card](#).
- 6 Replace the [base cover](#).
- 7 Replace the [keyboard](#).
- 8 Replace the [optical drive](#).
- 9 Replace the [battery](#).



# Removing the system board

---



**WARNING:** Before working inside your computer, read the safety information that shipped with your computer and follow the steps in [Before working inside your computer](#). After working inside your computer, follow the instructions in [After working inside your computer](#). For more safety best practices, see the Regulatory Compliance home page at [www.dell.com/regulatory\\_compliance](http://www.dell.com/regulatory_compliance).



**NOTE:** Your computer's Service Tag is stored in the system board. You must enter the Service Tag in the BIOS setup program after you replace the system board.



**NOTE:** Replacing the system board removes any changes you have made to the BIOS using the BIOS setup program. You must make the appropriate changes again after you replace the system board.



**NOTE:** Before disconnecting the cables from the system board, note the location of the connectors so that you can reconnect the cables correctly after you replace the system board.

## Prerequisites

- 1 Remove the [battery](#).
- 2 Remove the [optical drive](#).
- 3 Remove the [keyboard](#).
- 4 Remove the [base cover](#).
- 5 Remove the [wireless card](#).
- 6 Remove the [memory module](#).
- 7 Remove the [heat sink](#).

## Procedure

- 1 Open the latch, and disconnect the power-button board cable from the system board.
- 2 Peel the tape adhering the display cable to the system board.



- 3 Open the latch, and disconnect the display cable from the system board.

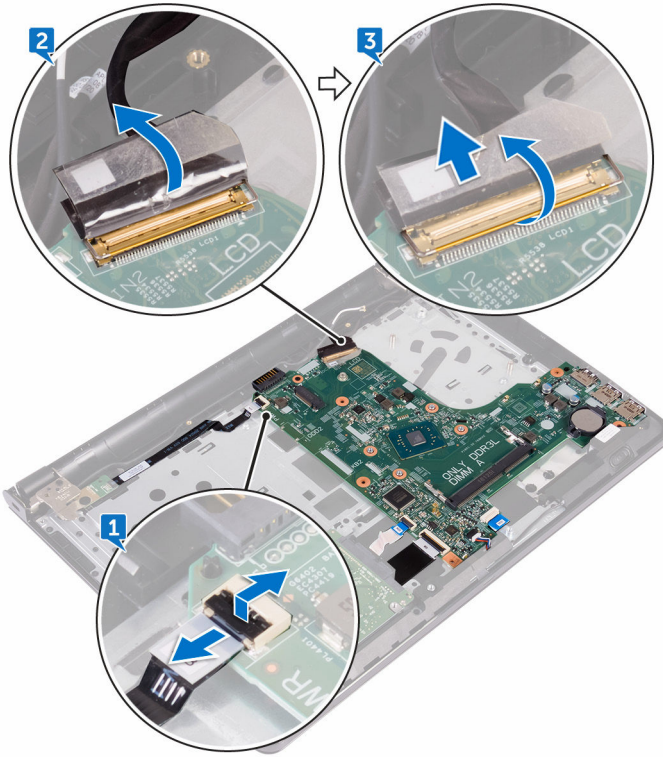

- 4 Open the latch, and disconnect the hard-drive cable from the system board.
- 5 Open the latch, and disconnect the I/O-board cable from the system board.
- 6 Disconnect the speaker cable from the system board.

- 7 Open the latch, and disconnect the touch-pad cable from the system board.

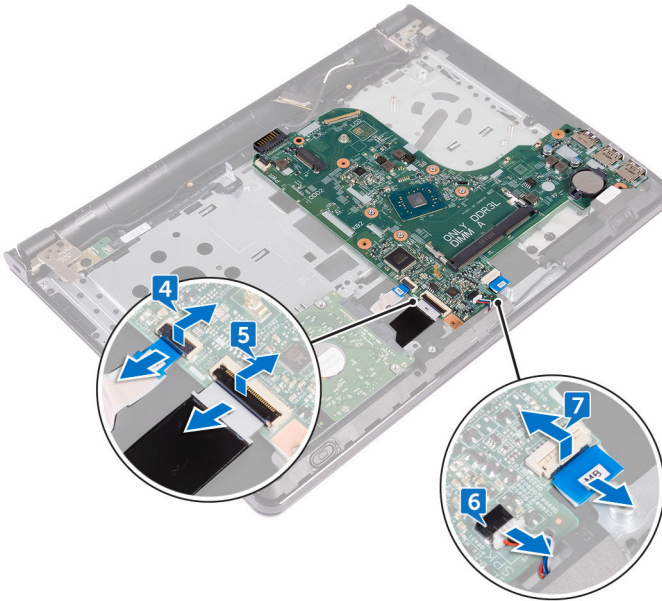

- 8 Remove the screw (M2x3) that secures the system board to the palm-rest assembly.

- 9 Gently release the ports on the system board from the slots and carefully turn the system board over.

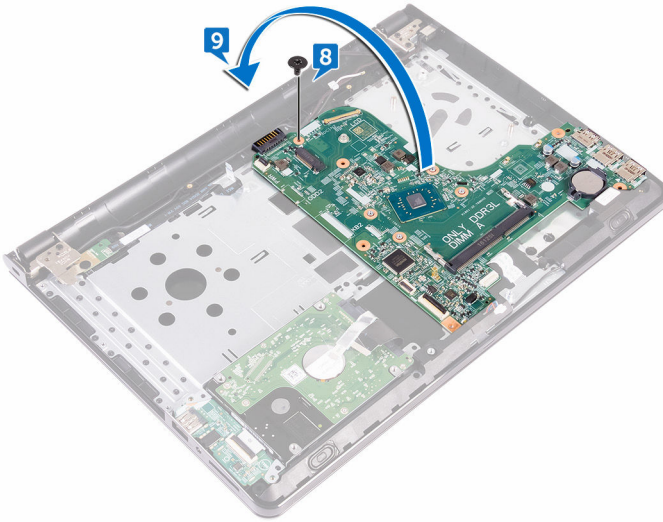

- 10 Peel the tape that secures the power-adaptor port cable to the system board.
- 11 Disconnect the power-adaptor port cable from the system board.

12 Lift the system board off the palm-rest assembly.

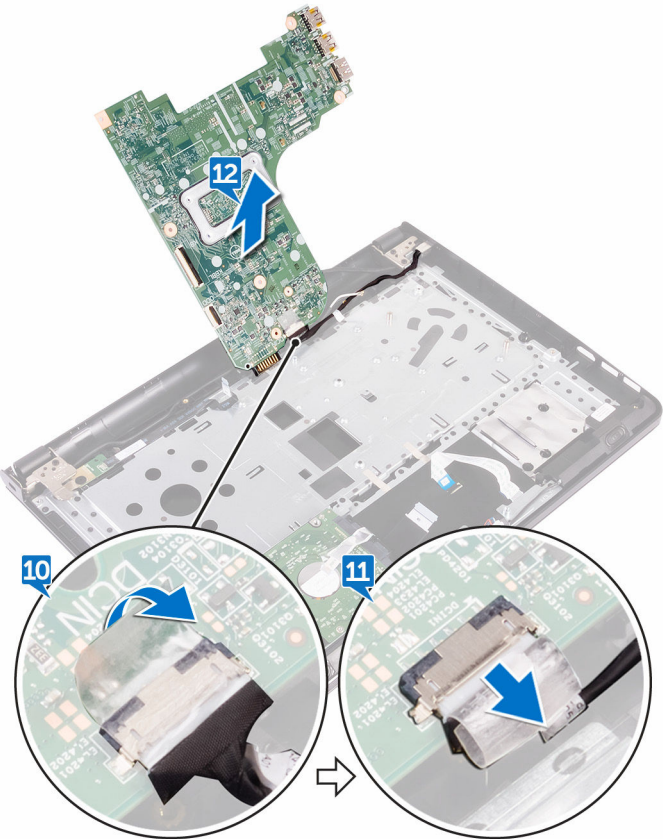

# Replacing the system board

---



**WARNING:** Before working inside your computer, read the safety information that shipped with your computer and follow the steps in [Before working inside your computer](#). After working inside your computer, follow the instructions in [After working inside your computer](#). For more safety best practices, see the Regulatory Compliance home page at [www.dell.com/regulatory\\_compliance](http://www.dell.com/regulatory_compliance).



**NOTE:** Your computer's Service Tag is stored in the system board. You must enter the Service Tag in the BIOS setup program after you replace the system board.



**NOTE:** Replacing the system board removes any changes you have made to the BIOS using the BIOS setup program. You must make the appropriate changes again after you replace the system board.

## Procedure

- 1 Connect the power-adapter port cable to the system board.
- 2 Adhere the tape that secures the power-adapter port cable to the system board.
- 3 Turn the system board over carefully.
- 4 Using the alignment post, place the system board on the palm-rest assembly.
- 5 Align the screw hole on the system board with the screw hole on the palm-rest assembly.
- 6 Replace the screw (M2x3) that secures the system board to the palm-rest assembly.
- 7 Slide the touch-pad cable into the system-board connector and close the latch to secure the cable.
- 8 Connect the speaker cable to the system board.
- 9 Slide the I/O-board cable, and hard-drive cable into their connectors on the system board and close the latches to secure the cables.
- 10 Slide the display cable into the connector on the system board and close the latch.
- 11 Adhere the tape that secures the display cable to the system board.

- 12 Slide the power-button board cable into the connector on the system board, and close the latch.

## Post-requisites

- 1 Replace the [heat sink](#).
- 2 Replace the [memory module](#).
- 3 Replace the [wireless card](#).
- 4 Replace the [base cover](#).
- 5 Replace the [keyboard](#).
- 6 Replace the [optical drive](#).
- 7 Replace the [battery](#).



# Removing the touch pad

---



**WARNING:** Before working inside your computer, read the safety information that shipped with your computer and follow the steps in [Before working inside your computer](#). After working inside your computer, follow the instructions in [After working inside your computer](#). For more safety best practices, see the Regulatory Compliance home page at [www.dell.com/regulatory\\_compliance](http://www.dell.com/regulatory_compliance).

## Prerequisites

- 1 Remove the [battery](#).
- 2 Remove the [optical drive](#).
- 3 Remove the [keyboard](#).
- 4 Remove the [base cover](#).
- 5 Remove the [memory module](#).
- 6 Remove the [hard drive](#).
- 7 Remove the [wireless card](#).
- 8 Remove the [I/O board](#).
- 9 Remove the [display assembly](#).
- 10 Remove the [system board](#).
- 11 Remove the [speakers](#).

## Procedure

- 1 Open the latch, and disconnect the touch-pad cable from the touch pad.



- 2 Lift the transparent film on the palm-rest assembly.

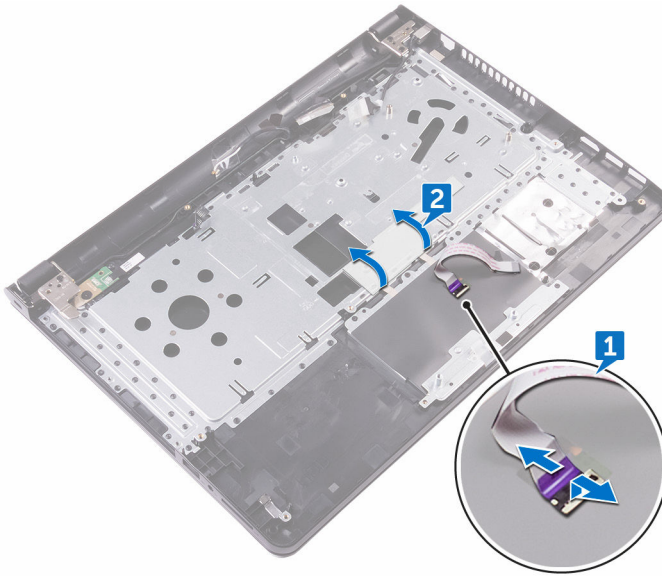

- 3 Peel the tapes that secure the touch-pad board to the palm-rest assembly.
- 4 Remove the screw (M2x3) that secures the touch-pad bracket to the palm-rest assembly.

- 5 Release the touch-pad bracket from the tab, and lift it at an angle.

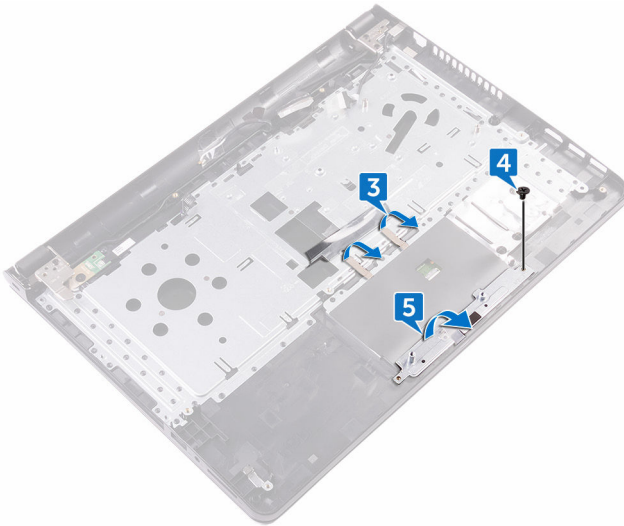

- 6 Remove the six screws (M2x3) that secure the touch-pad board to the palm-rest assembly.
- 7 Lift the touch-pad board off the palm-rest assembly.

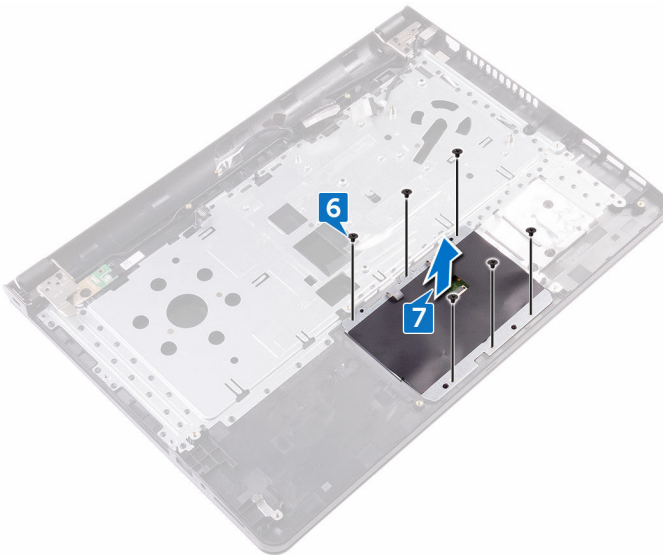

- 8 Lift the touch pad off the palm-rest assembly.

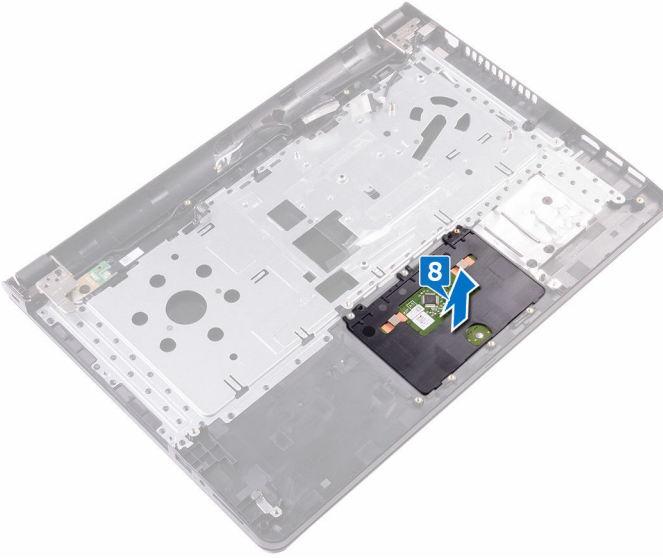

# Replacing the touch pad

---



**WARNING:** Before working inside your computer, read the safety information that shipped with your computer and follow the steps in [Before working inside your computer](#). After working inside your computer, follow the instructions in [After working inside your computer](#). For more safety best practices, see the Regulatory Compliance home page at [www.dell.com/regulatory\\_compliance](http://www.dell.com/regulatory_compliance).

## Procedure

- 1 Slide and replace the touch pad into its slot on the palm-rest assembly.
- 2 Align the screw holes on the touch-pad board with the screw holes on the palm-rest assembly.
- 3 Replace the six screws (M2x3) that secure the touch-pad board to the palm-rest assembly.
- 4 Slide the touch-pad bracket at an angle and align the screw hole on the touch-pad bracket with the screw hole on the palm-rest assembly.
- 5 Replace the screw (M2x3) that secures the touch-pad bracket to the palm-rest assembly.
- 6 Adhere the tapes that secure the touch-pad board to the palm-rest assembly and cover the tapes with the transparent film.
- 7 Connect the touch-pad cable to its connector and close the latch.

## Post-requisites

- 1 Replace the [speakers](#).
- 2 Replace the [system board](#).
- 3 Replace the [display assembly](#).
- 4 Replace the [I/O board](#).
- 5 Replace the [hard drive](#).
- 6 Replace the [wireless card](#).
- 7 Replace the [memory module](#).
- 8 Replace the [base cover](#).

- 9 Replace the [keyboard](#).
- 10 Replace the [optical drive](#).
- 11 Replace the [battery](#).



# Removing the power-adapter port

---



**WARNING:** Before working inside your computer, read the safety information that shipped with your computer and follow the steps in [Before working inside your computer](#). After working inside your computer, follow the instructions in [After working inside your computer](#). For more safety best practices, see the Regulatory Compliance home page at [www.dell.com/regulatory\\_compliance](http://www.dell.com/regulatory_compliance).

## Prerequisites

- 1 Remove the [battery](#).
- 2 Remove the [optical drive](#).
- 3 Remove the [keyboard](#).
- 4 Remove the [base cover](#).
- 5 Remove the [memory module](#).
- 6 Remove the [wireless card](#).
- 7 Remove the [display assembly](#).
- 8 Remove the [power-button board](#).
- 9 Remove the [system board](#).

## Procedure

- 1 Remove the screw (M2x3) that secures the power-adapter port to the palm-rest assembly.



- 2 Lift the power-adapter port along with its cable off the palm-rest assembly.

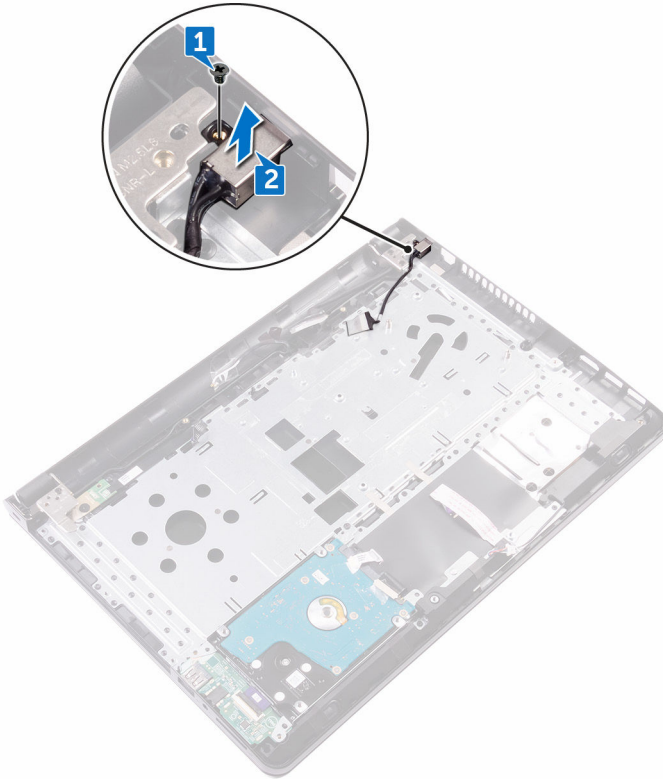

# Replacing the power-adapter port

---



**WARNING:** Before working inside your computer, read the safety information that shipped with your computer and follow the steps in [Before working inside your computer](#). After working inside your computer, follow the instructions in [After working inside your computer](#). For more safety best practices, see the Regulatory Compliance home page at [www.dell.com/regulatory\\_compliance](http://www.dell.com/regulatory_compliance).

## Procedure

- 1 Align the screw hole on the power-adapter port with the screw hole on the palm-rest assembly.
- 2 Replace the screw (M2x3) that secures the power-adapter port to the palm-rest assembly.

## Post-requisites

- 1 Replace the [system board](#).
- 2 Replace the [power-button board](#).
- 3 Replace the [display assembly](#).
- 4 Replace the [wireless card](#).
- 5 Replace the [memory module](#).
- 6 Replace the [base cover](#).
- 7 Replace the [keyboard](#).
- 8 Replace the [optical drive](#).
- 9 Replace the [battery](#).



# Removing the display back-cover and antenna assembly

---



**WARNING:** Before working inside your computer, read the safety information that shipped with your computer and follow the steps in [Before working inside your computer](#). After working inside your computer, follow the instructions in [After working inside your computer](#). For more safety best practices, see the Regulatory Compliance home page at [www.dell.com/regulatory\\_compliance](http://www.dell.com/regulatory_compliance).

## Prerequisites

- 1 Remove the [battery](#).
- 2 Remove the [optical drive](#).
- 3 Remove the [keyboard](#).
- 4 Remove the [base cover](#).
- 5 Remove the [display assembly](#).
- 6 Remove the [display bezel](#).
- 7 Remove the [display panel](#).
- 8 Remove the [camera](#).
- 9 Remove the [display hinges](#).
- 10 Remove the [display cable](#).

## Procedure

After performing all the prerequisites, we are left with the display back-cover and antenna assembly.



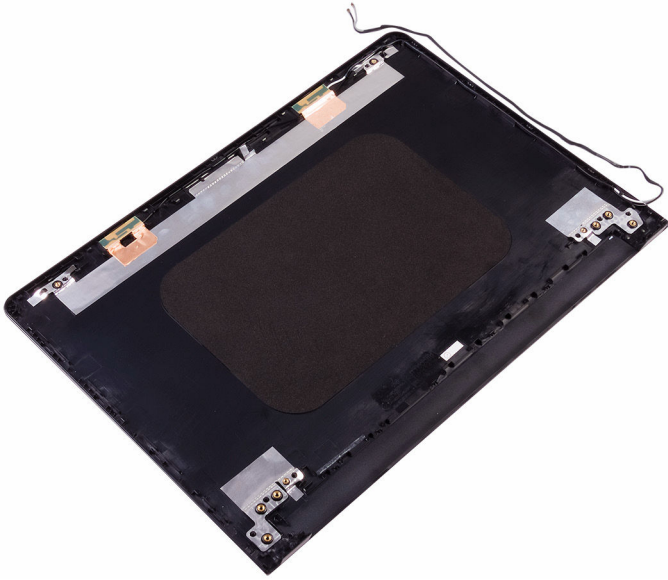

# Replacing the display back-cover and antenna assembly

---



**WARNING:** Before working inside your computer, read the safety information that shipped with your computer and follow the steps in [Before working inside your computer](#). After working inside your computer, follow the instructions in [After working inside your computer](#). For more safety best practices, see the Regulatory Compliance home page at [www.dell.com/regulatory\\_compliance](http://www.dell.com/regulatory_compliance).

## Procedure

Place the display back-cover on a flat surface.

## Post-requisites

- 1 Replace the [camera](#).
- 2 Replace the [display cable](#).
- 3 Replace the [display hinges](#).
- 4 Replace the [display panel](#).
- 5 Replace the [display bezel](#).
- 6 Replace the [display assembly](#).
- 7 Replace the [base cover](#).
- 8 Replace the [keyboard](#).
- 9 Replace the [optical drive](#).
- 10 Replace the [battery](#).



# Removing the palm rest

---



**WARNING:** Before working inside your computer, read the safety information that shipped with your computer and follow the steps in [Before working inside your computer](#). After working inside your computer, follow the instructions in [After working inside your computer](#). For more safety best practices, see the Regulatory Compliance home page at [www.dell.com/regulatory\\_compliance](http://www.dell.com/regulatory_compliance).

## Prerequisites

- 1 Remove the [battery](#).
- 2 Remove the [optical drive](#).
- 3 Remove the [keyboard](#).
- 4 Remove the [base cover](#).
- 5 Remove the [memory module](#).
- 6 Remove the [hard drive](#).
- 7 Remove the [wireless card](#).
- 8 Remove the [I/O board](#).
- 9 Remove the [speakers](#).
- 10 Remove the [heat sink](#).
- 11 Remove the [touch pad](#).
- 12 Remove the [power-button board](#).
- 13 Remove the [system board](#).
- 14 Remove the [power-adaptor port](#).

# Procedure

After performing the steps in prerequisites, we are left with the palm rest.



# Replacing the palm rest

---



**WARNING:** Before working inside your computer, read the safety information that shipped with your computer and follow the steps in [Before working inside your computer](#). After working inside your computer, follow the instructions in [After working inside your computer](#). For more safety best practices, see the Regulatory Compliance home page at [www.dell.com/regulatory\\_compliance](http://www.dell.com/regulatory_compliance).

## Procedure

Place the palm rest on a flat surface.

## Post-requisites

- 1 Replace the [power-adapter port](#).
- 2 Replace the [system board](#).
- 3 Replace the [power-button board](#).
- 4 Replace the [touch pad](#).
- 5 Replace the [heat sink](#).
- 6 Replace the [speakers](#).
- 7 Replace the [I/O board](#).
- 8 Replace the [wireless card](#).
- 9 Replace the [hard drive](#).
- 10 Replace the [memory module](#).
- 11 Replace the [base cover](#).
- 12 Replace the [keyboard](#).
- 13 Replace the [optical drive](#).
- 14 Replace the [battery](#).

# Diagnostics

---

## Power and battery-status light/hard-drive activity light

Indicates the battery-charge status or the hard-drive activity.

 **NOTE: Press Fn+H to toggle this light between power and battery-status light and hard-drive activity light.**

### Hard-drive activity light

Turns on when the computer reads from or writes to the hard drive.

### Power and battery-status light

Indicates the power and battery-charge status.

**Solid white** — Power adapter is connected and the battery has more than 5 percent charge.

**Amber** — Computer is running on battery and the battery has less than 5 percent charge.

### Off

- Power adapter is connected and the battery is fully charged.
- Computer is running on battery and the battery has more than 5 percent charge.
- Computer is in sleep state, hibernation, or turned off.

The power and battery-status light blinks amber along with beep codes indicating failures.

For example, the power and battery-status light blinks amber two times followed by a pause, and then blinks white three times followed by a pause. This 2,3 pattern continues until the computer is turned off indicating no memory or RAM is detected.

The following table shows the different power and battery-status light patterns and the problems that each light pattern indicate.

**Table 3. Light patterns**

Light pattern	Problem description
2,1	CPU failure
2,2	System board: BIOS and ROM failure
2,3	No memory or RAM detected



Light pattern	Problem description
2,4	Memory or RAM failure
2,5	Invalid memory installed
2,6	System board or chipset error
2,7	LCD failure
3,1	CMOS battery failure
3,2	PCI or video card or chip failure
3,3	Recovery image not found
3,4	Recovery image found but invalid

**Camera status light:** Indicates whether the camera is in use.

- Solid white — Camera is in use.
- Off — Camera is not in use.

**Caps Lock status light:** Indicates whether Caps Lock is enabled or disabled.

- Solid white — Caps Lock enabled.
- Off — Caps Lock disabled.



# Getting help and contacting Dell

---

## Self-help resources

You can get information and help on Dell products and services using these self-help resources:

### Table 4. Self-help resources

Information about Dell products and services

[www.dell.com](http://www.dell.com)

Dell Help & Support app



Get started app



Accessing help

In Windows search, type `Help and Support`, and press Enter.

Online help for operating system

[www.dell.com/support/windows](http://www.dell.com/support/windows)

[www.dell.com/support/linux](http://www.dell.com/support/linux)

Troubleshooting information, user manuals, setup instructions, product specifications, technical help blogs, drivers, software updates, and so on.

[www.dell.com/support](http://www.dell.com/support)

Learn about your operating system, setting up and using your computer, data backup, diagnostics, and so on.

See *Me and My Dell* at [www.dell.com/support/manuals](http://www.dell.com/support/manuals).

## Contacting Dell

To contact Dell for sales, technical support, or customer service issues, see [www.dell.com/contactdell](http://www.dell.com/contactdell).





**NOTE: Availability varies by country and product, and some services may not be available in your country.**



**NOTE: If you do not have an active internet connection, you can find contact information on your purchase invoice, packing slip, bill, or Dell product catalog.**